

# Operating Manual

## FC-PRO

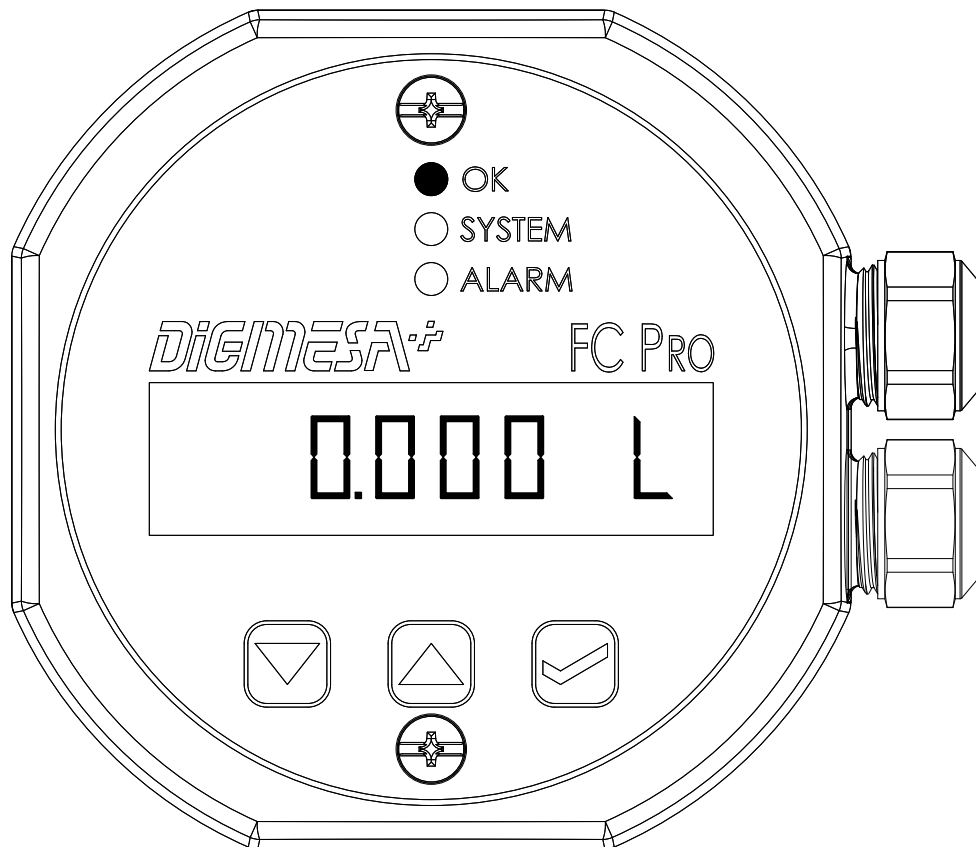

# **DIGIMESA**

---

Digimesa AG, Keltenstrasse 31, CH-2563 Ipsach / Switzerland

Phone +41 (32) 332 77 77, Fax +41 (32) 332 77 88

[www.digimesa.com](http://www.digimesa.com)

## Table of contents

1.	Safety instructions	3
2.	Introduction	4
3.	FC PRO	4
4.	Connection diagram	5
5.	Functions and query options	5
6.	Display	6
7.	Reset	7
8.	Query history	8
9.	Programming and settings	10
10.	Alarm function (limit value in the Day counter)	11
11.	P/L pulses per litre, manual	12
12.	AUTO P/L pulses per litre, automatic	13
13.	CODE	14
14.	Programming diagram	15
15.	Query diagram	16
16.	Technical data	17
17.	Dimensions	18

# 1. Safety instructions

1. Please read through this Operating Manual very carefully before putting the device into service. Carry out all steps strictly according to the instructions.
2. Take note of all instructions and illustrations.
3. Make sure the housing is fitted correctly again after opening. Otherwise foreign bodies and moisture could penetrate the device.
4. In the following cases, the 230 V power supply must be disconnected immediately and a technician called in:
  - Water or other liquids have penetrated the device
  - In spite of having carefully followed all of the instructions given in this Operating Manual, the unit is not operating correctly
  - If the unit is dropped and the housing damaged
  - If the display on the unit is not working
  - If one of the three buttons does not work

Under no circumstances must you attempt to repair anything yourself or try to get things working by randomly pressing the buttons.



The device and the flow sensor are not protected against overvoltage and polarity reversal.



The integrated electronic system will not work without a power supply. If the device is operated without a power supply, measurement is impossible.

## 1.1 Installation

The device may only be installed by qualified specialist personnel while observing customary local safety regulations.

During installation, make sure of the following:

- The direction of flow corresponds to the label on the unit
- The measuring device must be fitted in a horizontal position
- The unit must not be subjected to any mechanical stresses
- Only seals and connectors suitable for the planned operating conditions must be used
- The pipework upstream and downstream of the device must be appropriately supported
- The system must be vented before it is put into operation

## 2. Introduction

The FC PRO is an all-purpose electronic display and evaluation unit for operation with approved DIGMESA AG flow sensors.

The FC PRO is used as an external display unit and is connected to the flow sensor by means of a cable.

The FC PRO has been developed to measure and control the consumption of liquids. The built-in LCD display informs the user of the volume that has flowed through and the current flow rate. The alarm function is used to indicate when a defined volume has been reached. A protective code prevents manipulation by non-authorized persons.

Application examples:

- Monitoring filter cartridges
- Monitoring ion exchangers
- Checking drinks servings
- Monitoring cooling circuits
- etc...

## 3. FC PRO

Electrical supply via power pack with 230 V standardised plug or a screw terminal with 5-24VDC\*

Backlighting

3 function LEDs: OK „green“, System „orange“, Alarm „red“

2 cable clamping sleeves

1 x input flow sensor

1 x relay output (alarm)

Housing material: polypropylene (PP)

Water resistance: IPx4

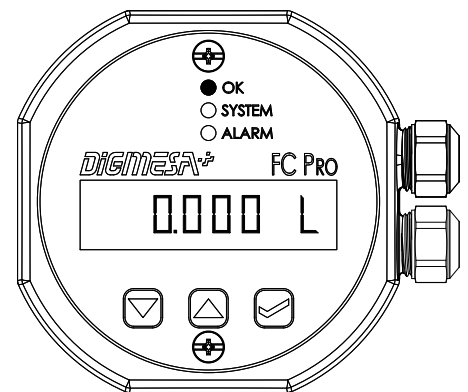

Optional accessories:

Item number #910-0002

AC/DC adapter 

Input: 100-240 VAC

Output: 12V/270mA

Cable length: 2 metres

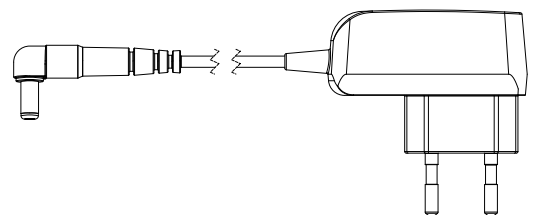

\* Do not exceed or fall below the power requirement of the flow sensor

## 4. Connection diagram

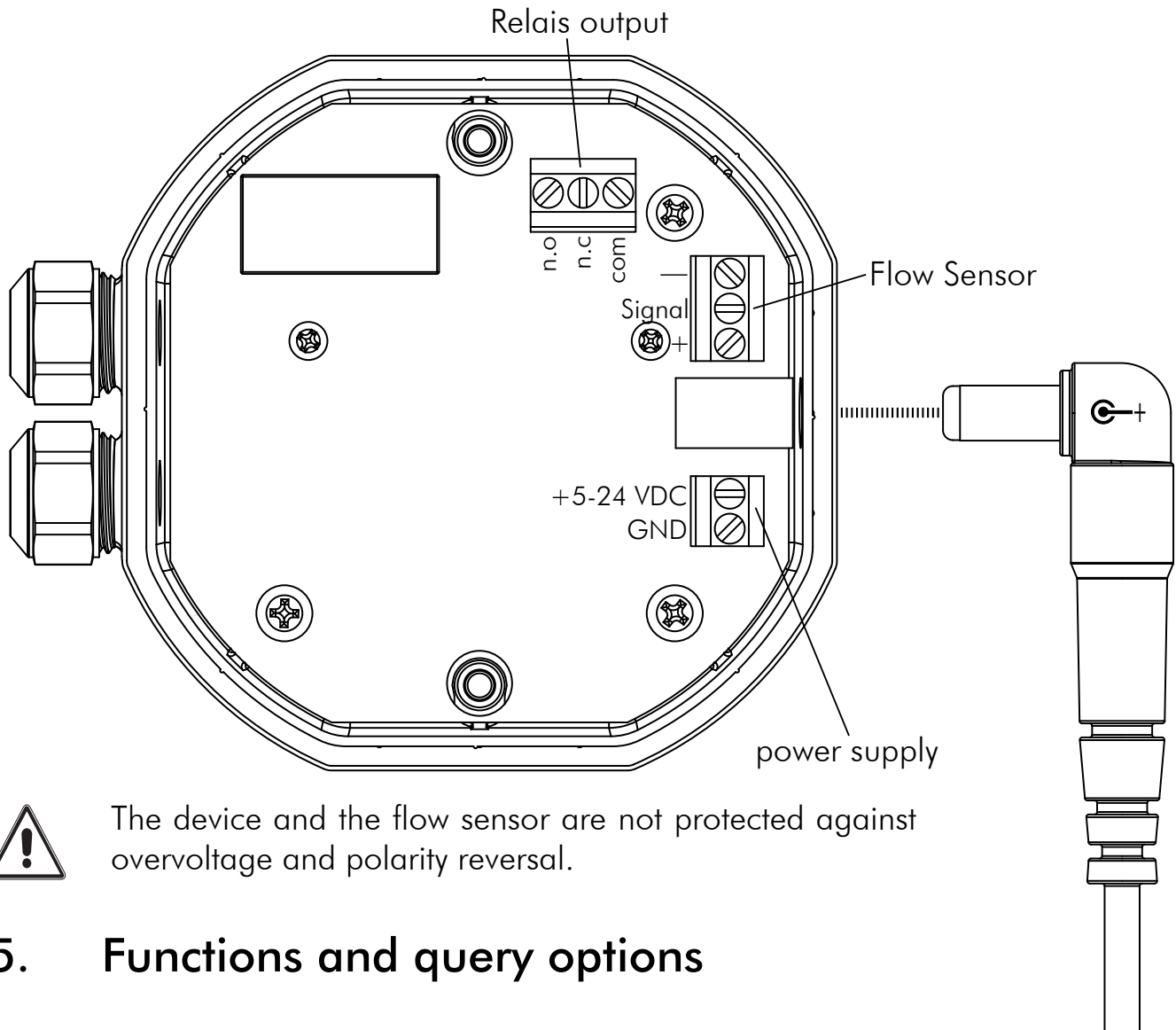

The device and the flow sensor are not protected against overvoltage and polarity reversal.

## 5. Functions and query options

Measurement: Day counter up to 999'999 litres  
 Current value up to 99.99 l/min  
 Total counter up to 99'999 Liter

Decimal places: 1-4 pul/l = none  
 5-49 pul/l = 0.0  
 50 -499 pul/l = 0.00  
 >500 pul/l = 0.000

Settings: Limit value with alarm (filter cartridges, etc.) max. 99'999 litres. Once 90% of the set value has been reached, the Alarm LED flashes.

Once the set value is reached on the Day counter, the Alarm LED stays illuminated all the time and the relais output is set.

Pulses per litre, manual can be set to max. 65,535 pulses.

Pulses per litre, automatic can be set to max. 999.999 litres.

4-character protection code.

## 6. Display

OK LED is illuminated.



The Day counter can display up to 999'999 litres. Depending on the pul/l value, up to 3 decimal places are displayed.

If the Mode button is pressed once, the display switches to the Current value.



The Current value indicates the current flow rate in litres per minute (l/min).

If the Mode button is pressed once, the display switches to the Total counter.



The Total counter is a second counter for a max. of 99'999 litres. It can be protected against (inadvertent/unauthorised) resetting by a code. If the Mode button is pressed once again, the display switches back to Day counter.



## 7. Reset



The last 5 resets are saved, with PoS 1 always being the latest zero setting.

OK LED is illuminated.

● OK

### RESET DAY COUNTER

Select the Day counter on the display and hold down the Down and Up buttons simultaneously until RESET appears briefly on the display and then the Day counter reset to zero.

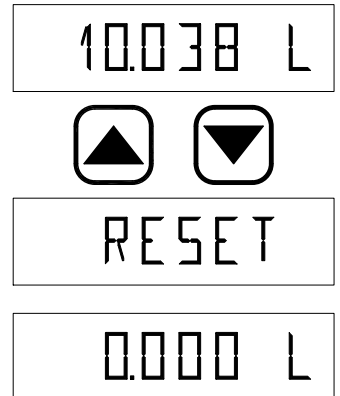

### RESET TOTAL COUNTER

Select the Total counter on the display and hold down the Down and Up buttons simultaneously until RESET appears briefly on the display and then the Total counter reset to zero.

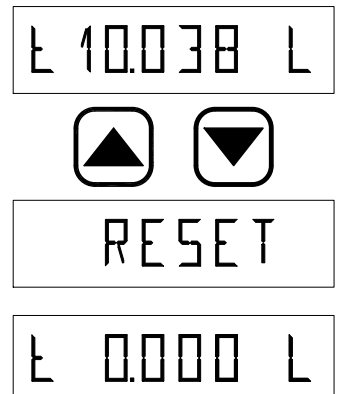

If the unit is protected by a code, you will be requested to enter this code (Code, Chapter 14).

## 8. Query history



Only the historic values of the selected counter are displayed.

OK LED is illuminated.



Select the Day counter or Total counter on the display and keep the Down button pressed for 5 seconds.

0.000 L

0.000 L



PoS 1 is now shown on the display alternatively with the saved value.

PoS 1

10.038 L

PoS 1

To query PoS 2, press the Up button briefly.



PoS 2 is now shown on the display alternatively with the saved value.

PoS 2

4.992 L

PoS 2



To query PoS 3, press the Up button briefly, then PoS 3 will be shown on the display alternatively with the saved value. If the Up button is pressed again, PoS 4 is displayed, and then if the Up button is pressed again, PoS 5 is displayed.



If no value is saved in one of the PoS 1 to 5, then „No dATA“ appears and the display goes back to the last PoS that has saved a value.

PoS 3

No dATA

Each time you press the Down button, you go back by one PoS. To go back to Counter, keep the Down button pressed for 5 seconds.



0.000 L

## 9. Programming and settings

Select Day counter or Total counter on the display and keep the Mode button pressed for 5 seconds.



If the unit is protected by a code, you will be requested to enter this code (Code, Chapter 14).

SYSTEM LED is illuminated.

ALAR<sub>m</sub> is shown on the display.  
Setting is described on page 11.



In Setting mode, if no button is pressed for 30 seconds, the display goes back to the Day counter.

If the Up button is pressed once, the display switches to P/L (pulses per litre, manual). It returns to Alarm with the Down button.

P/L setting is described on page 12.

If the Up button is pressed one more time, the display switches to Auto P/L (pulses per litre, automatic). It returns to P/L with the Down button.

AUTO P/L setting is described on page 13.

If the Up button is pressed once again, the display switches to CO<sub>d</sub>E setting. It returns to AUTO P/L with the Down button.

CO<sub>d</sub>E setting is described on page 14.

Hold down the Mode button for 5 seconds to switch back to Day counter or Total counter.

0.000 L

⌂ 0.000 L



● SYSTEM

ALAR<sub>m</sub>



P/L



AUTO P/L



CO<sub>d</sub>E



0.000 L

⌂ 0.000 L

## 10. Alarm function (limit value in the Day counter)



The alarm function is deactivated with 00000.

Select Day counter or Total counter and keep the Mode button pressed for 5 seconds.

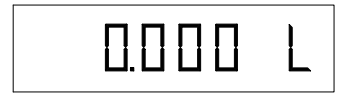

If the unit is protected by a code, you will be requested to enter this code (Code, Chapter 14).



● SYSTEM

SYSTEM LED is illuminated.

ALAR<sub>m</sub> is shown on the display.



In Setting mode, if no button is pressed for 30 seconds, the display goes back to the Day counter.

Press the Mode button once again to switch to the Setting value.



Then set the required alarm value in litres.

Use the Down/Up buttons to change the value and the Mode button to switch to the next digit.

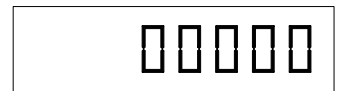

For example, a value of 15'000 litres:

Press Mode button 3x, Up button 5x, Mode button 1x, Up button 1x and then press the Mode button.

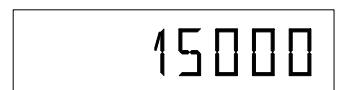

ALAR<sub>m</sub> is shown on the display.



Press the Up button once briefly to switch to P/L setting (pulses per litre, manual). Or press the Mode button for 5 seconds to go back to the Day counter.



## 11. P/L pulses per litre, manual

Select Day counter or Total counter and keep the Mode button pressed for 5 seconds.



If the unit is protected by a code, you will be requested to enter this code (Code, Chapter 14).

SYSTEM LED is illuminated.

ALARM is shown on the display.



In Setting mode, if no button is pressed for 30 seconds, the display goes back to the Day counter.

Press the Up button once to switch to P/L setting (pulses per litre, manual).

P/L is shown on the display.

Now, press the Mode button again to switch to the Setting value.

Adjust the pul/l value of the flow sensor connected. Use the Down/Up buttons to change the value and the Mode button to switch to the next digit.

For example, a value of 1'000 pulses per litre:

Press Mode button 3x, Up button 1x and then Mode button 2x. P/L is shown on the display.

Press the Up button once briefly to switch to AUTO P/L setting (pulses per litre, automatic). Or press the Mode button for 5 seconds to go back to the Day counter.

0.000 L

L 0.000 L



● SYSTEM

ALARM



P/L



00000



0 1000

P/L



## 12. AUTO P/L pulses per litre, automatic

Select Day counter or Total counter and keep the Mode button pressed for 5 seconds.



If the unit is protected by a code, you will be requested to enter this code (Code, Chapter 14).

SYSTEM LED is illuminated.

ALARm is shown on the display.



In Setting mode, if no button is pressed for 30 seconds, the display goes back to the Day counter.

Press the Up button twice to switch to AUTO P/L setting (pulses per litre, automatic).

AUTO P/L is shown on the display. Now press the Mode button once again to automatically start calibration. On the display, a line appears that moves from right to left during data acquisition.

Now allow approximately 1.0 litre of medium to flow through. Afterwards press the Mode button once.

Set the measured quantity (set of scales/graduated beaker) in litres here. Use the Down/Up buttons to change the value and the Mode button to switch to the next digit.

For example, a value of 1.038 Liter:

Press Up button 8x, Mode button 1x, Up button 3x, Mode button 2x, Up button 1x and Mode button 2x.

AUTO P/L is shown on the display.

Press the Up button once briefly to switch to COdE setting. Or press the Mode button for 5 seconds to go back to the Day counter.

0.000 L

0.000 L



● SYSTEM

ALARm



AUTO P/L



— — — — —



000.000 L



00 1.038 L

AUTO P/L



# 13. CODE



Make a note of the code that is entered, as without it all the important functions are blocked.

The Code function is deactivated with 0000.

Select Day counter or Total counter and keep the Mode button pressed for 5 seconds.



If the unit is protected by a code, you will be requested to enter this code.

SYSTEM LED is illuminated.

ALARm is shown on the display.



In Setting mode, if no button is pressed for 30 seconds, the display goes back to the Day counter.

Press the Up button 3 times to switch to COdE setting.

COdE appears on the display. Now press the Mode button once again.

Enter your personal code here. Use the Down/Up buttons to change the value and the Mode button to switch to the next digit.

Sample code - 1234:

Press the Up button 4x, Mode button 1x, Up button 3x, Mode button 1x, Up button 2x, Mode button 1x, Up button 1x and Mode button 1x.

COdE is shown on the display.

You go back from one setting to the next each time you press the Down button briefly. Or press the Mode button for 5 seconds to go back to the Day counter.

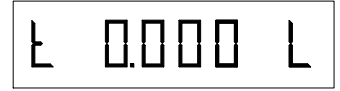
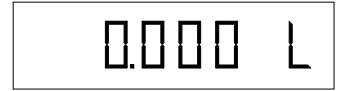

● SYSTEM

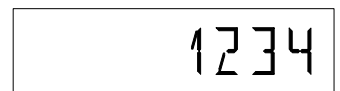
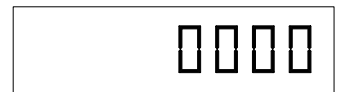
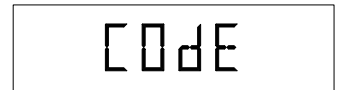

# 14. Programming diagram

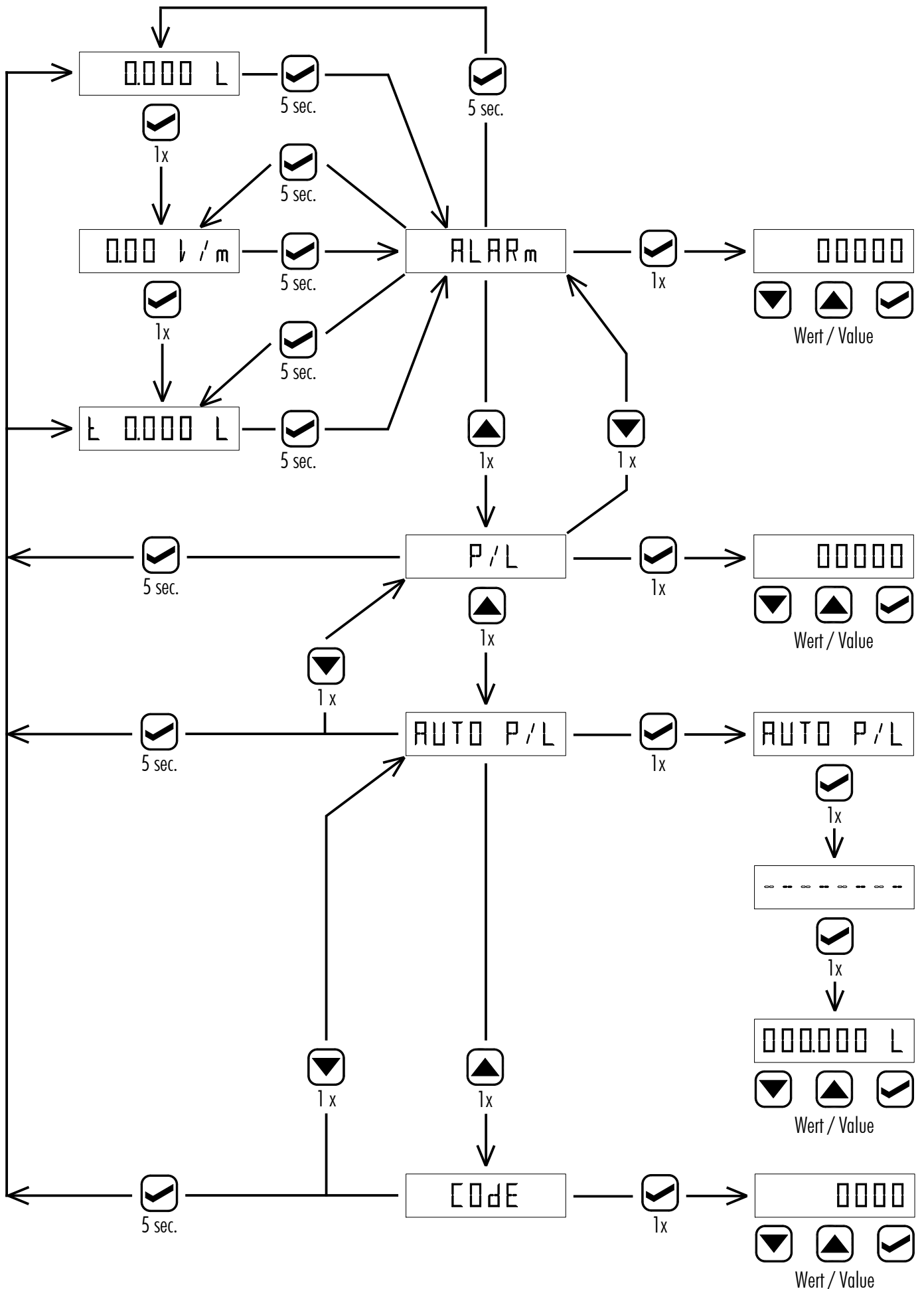

# 15. Query diagram

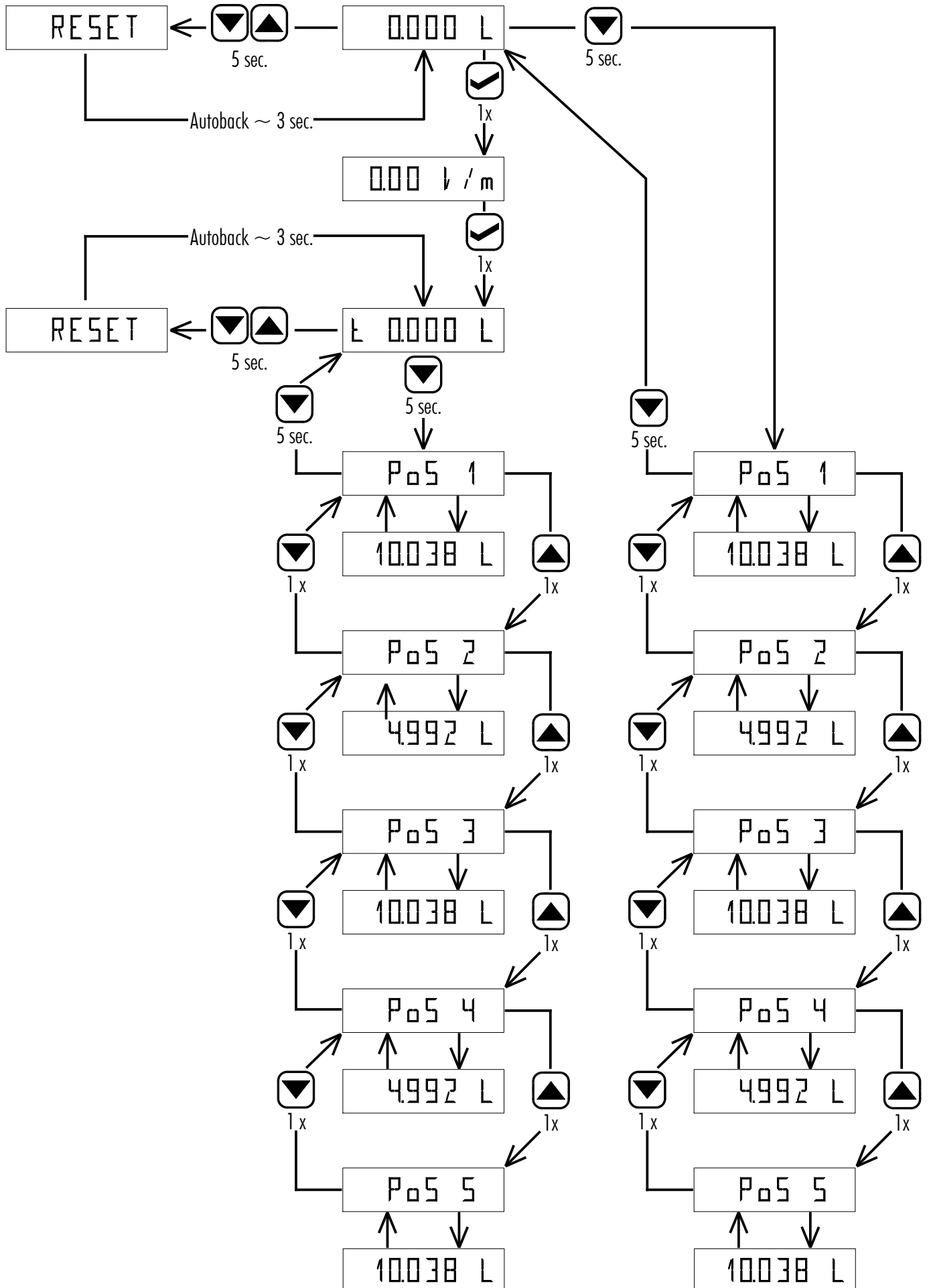



## 16. Technical data



The device and the flow sensor are not protected against overvoltage and polarity reversal.

### Display:

The display has 8 characters and each character has 14 segments. This makes it possible to show figures and letters for running text or units of measurement on the display.

### Technical data display

Display range: 8 characters (14-segment display, including decimal point and backlighting)

Temperature range: -10° to +60°C



### Electronic system:

At the heart of the display unit is a modern, 16-bit microcontroller.

### Technical data - electronic system

Temperature range: -10°C to +60°C

Options, power supply: Plug-in power supply: 230V / 12V/270mA  
5-24VDC\*

Current consumption: <90mA without flow sensor

Relay output: 24V/1A DC

\* Do not exceed or fall below the power requirement of the flow sensor

# 17. Dimensions

