

DATA SHEET

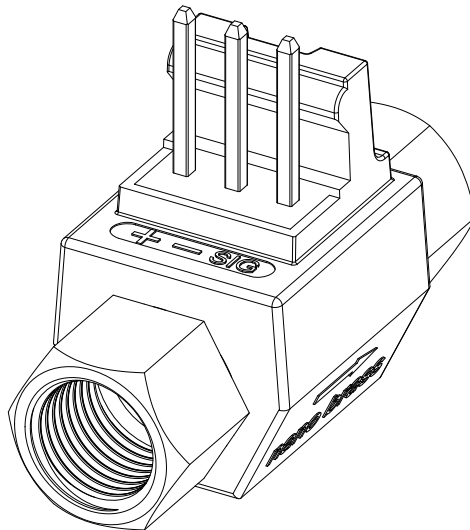

DIGimesa[®]
SWITZERLAND

nano brass
Part number: 9NB-11xx/03x

Digimesa AG, Keltenstrasse 31, CH-2563 Ipsach / Switzerland
Phone +41 (32) 332 77 77, Fax +41 (32) 332 77 88

www.digimesa.com

Version 03 Nano Brass FHC #9NB-11xx/03x GB Page 1-7

General Description

The Flow Sensor nano brass is a general-purpose device. It is employed for measuring, regulating or metering and guarantees most precise measurement of fluid quantities. In addition, a pulse generator integrated into the flowmeter guarantees a practically unlimited useful life.

Specific applications: Straight flow path, compact design.

Approvals / Standards

EN55014-1:00+A1:01+A2:02, EN61000-6-3:01+A11:04, IEC61000-6-3:06(ed.2.0), EN61000-3-2:06, IEC61000-3-2:05(ed.3.0), EN61000-3-3:95+A1:01+A2:05, IEC61000-3-3:94+A1:01+A2:05(Cons.ed 1.2), EN55014-2:97+A1:01, EN61000-6-1:01, IEC61000-6-1:05(ed.2), LFGB (EU 1935 /2004, EU10/2011)



Materials (wetted)

Housing: Lead free brass (CW510L)
 Bearing : PEEK
 Nozzle: PEEK
 Turbine: PVDF
 Magnete: Ceramic Sr Fe O
 (in contact with medium)

Technical data:

Linear range: from 0.035 - 0.70 l/min depending on the nozzle size
 Durability: min. 100'000 liters at max. flow (page 5-7)
 Measuring accuracy: +/- 2.0% *
 Temperature range: +0°C to +100°C
 32°F to 212°F
 Pressure range: 20 bar at 20°C
 290 psi /68°F
 Mounting position: freely selectable
 Nozzle size: Ø 1.0mm, 1.2mm, 1.4mm

* Accuracy in the linear range for individually calibrated equipment

Electrical connection ratings:

Power supply: +2.8 to +24 VDC
 Consumption: <8 mA
 Signal connection: Open collector, NPN
 Signal voltage: 0 VDC GND
 (saturation <0.7 V)
 Signal load: max. 20 mA
 Leakage current: max. 10 µA
 Connections: PANCON MAS-CON
 156 MLSS
 Signal: Square-wave output
 Duty Cycle: ~ 50%

Dimensions in mm:

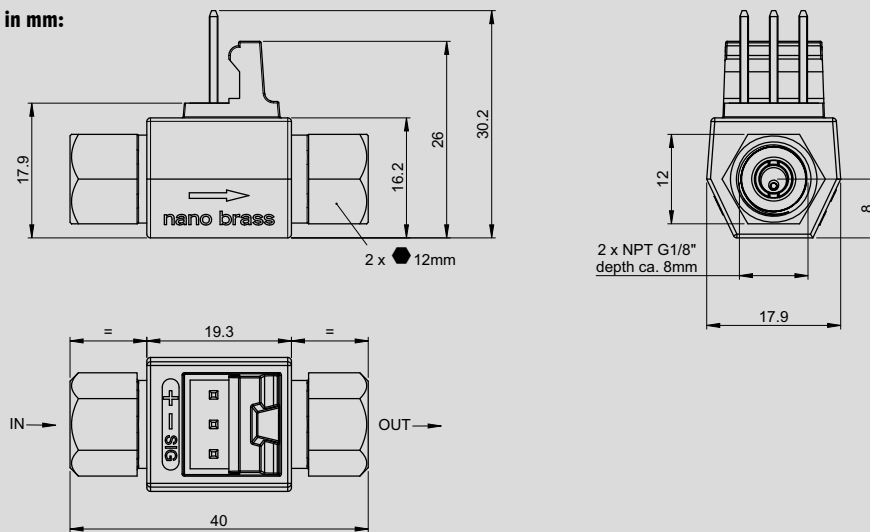

RESISTANCE

Special regulations which must be complied with by the flow sensor manufacturer apply to each country, e.g. CE, NSF, FDA and SK. The various media flowing through the flow sensor differ from application to application. You are advised to enquire with the medium manufacturer as to whether the entire installation and the flow sensor are resistant to the medium itself (see Material)!

ELECTRONIC

DIGMESA electronic circuitry is always designed for operation with DIGMESA flow sensors. Please note the following if connecting to other electronic circuitry:

- The flow sensor does not supply an output voltage but switches the signal terminal to 0 V ground (actuated) or leaves it open (non-actuated)
- There must be a pull-up resistor between power supply + and signal depending on electronic circuitry!

Installation instruction

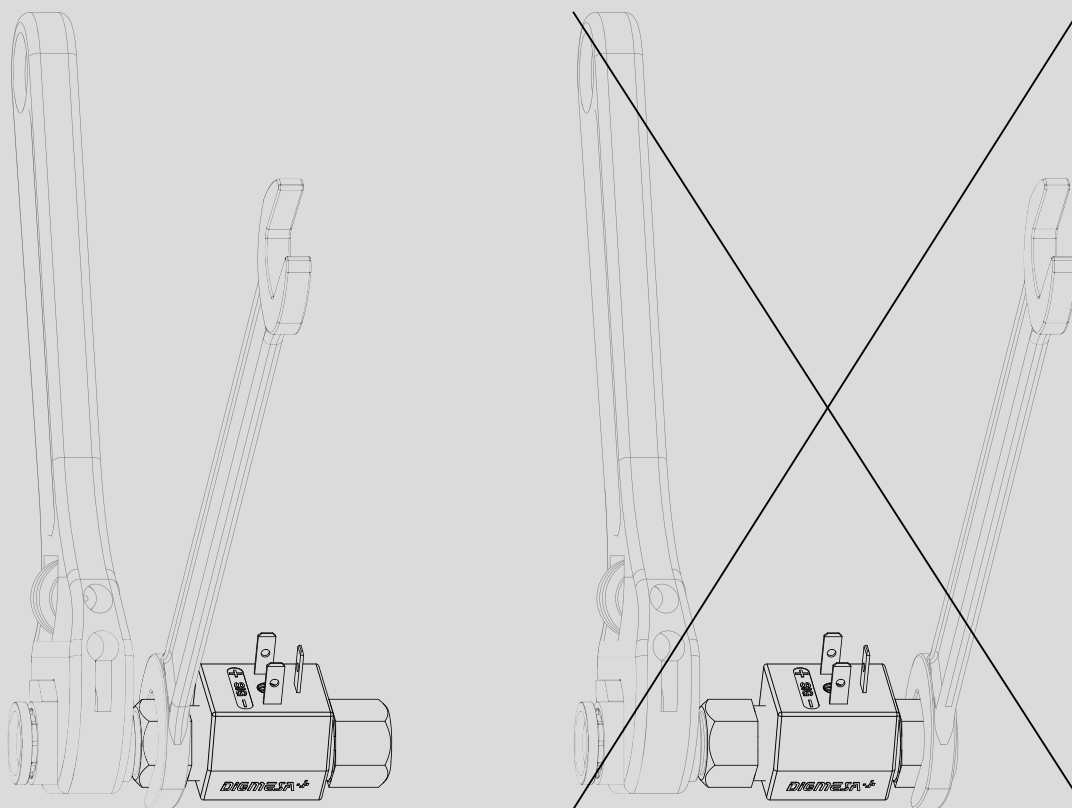

Important:
Fittings should be mounted torsion-free, max. 10 Nm torque!



Drying and/or operating with compressed air destroys the flow sensor!

DIGIMESA

Interface Connection: Examples Open collector

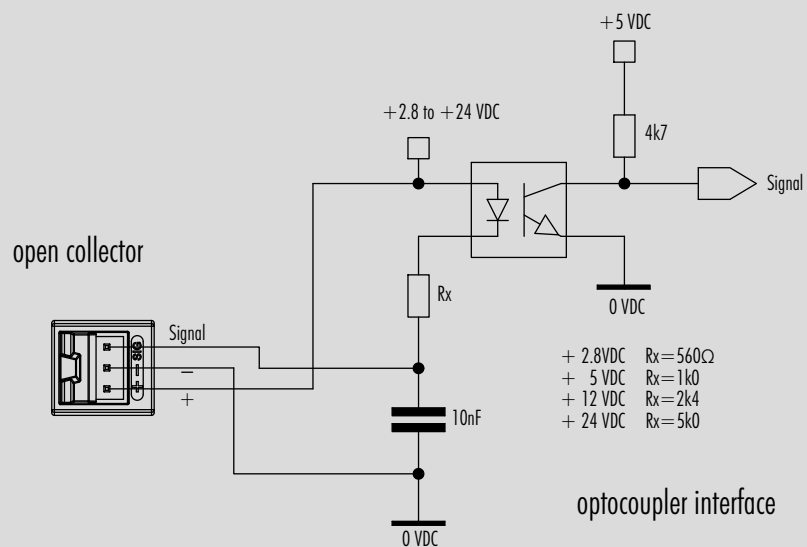
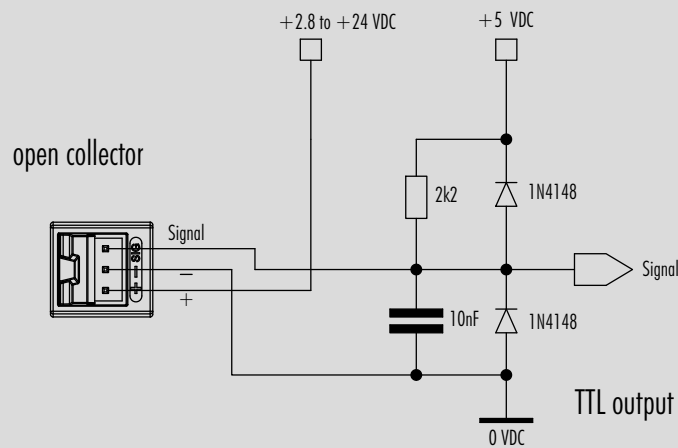
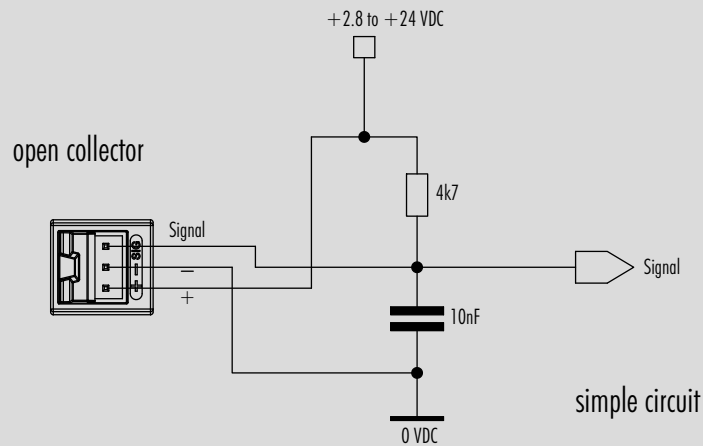

Measurement Curve nano brass Ø1.0mm

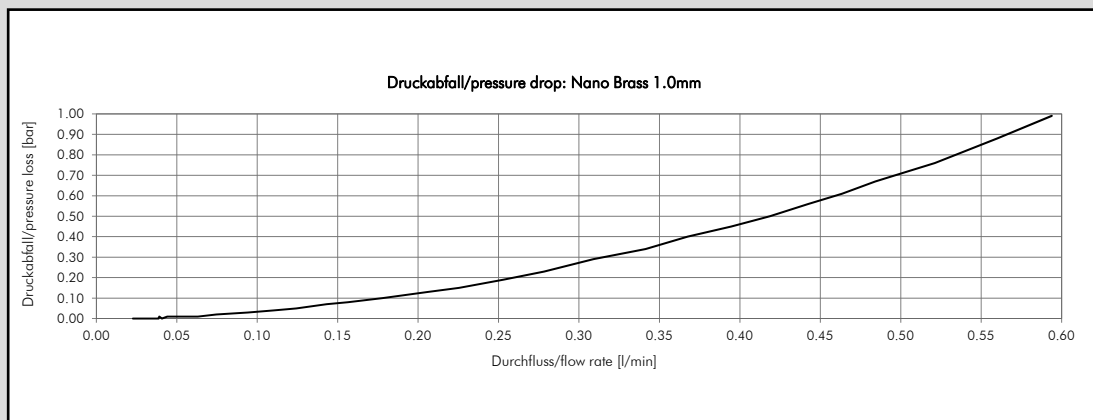
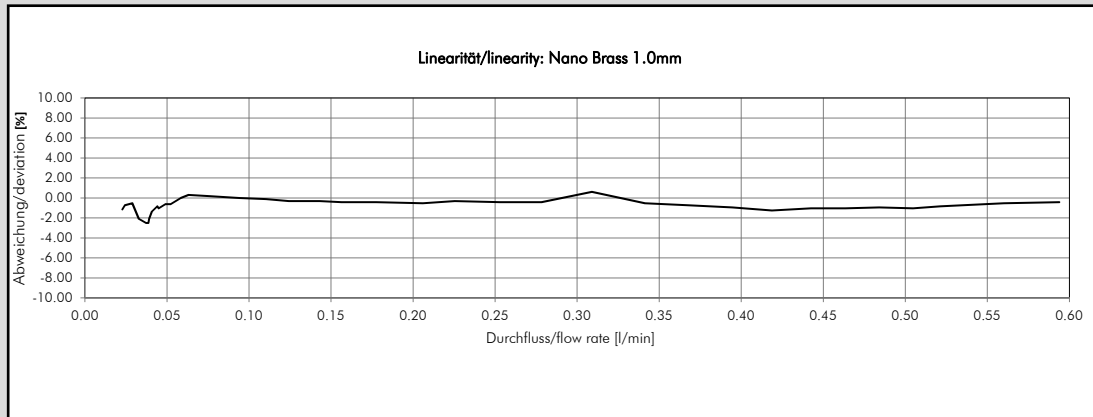

Medium: Water / Pressure: 3.5 bar

#9NB-1100/03 with pulse divider

Nozzle size	Pulses/Litre	ml/pulse	min. flow rate [l/min]	max. flow rate [l/min]	Pulse frequency [Hz] min/max
Ø 1.0 mm	2'494	0.40	0.035	0.40	~1.4 / 17

#9NB-1100/03A without pulse divider

Nozzle size	Pulses/Litre	ml/pulse	min. flow rate [l/min]	max. flow rate [l/min]	Pulse frequency [Hz] min/max
Ø 1.0 mm	39'900	0.025	0.035	0.40	~23 / 270

The values specified must be considered as approximate values.

The number of pulses per litre may differ depending on medium and installation.

We recommend to calibrate the number of pulses per litre in line with the complete installation.

MEASUREMENT TIPS

- Ensure that there is no fast-pulsatory movement of the media
- Ensure that there are no reverse pressure surges
- Ensure that there is no air in the system
- Keep the pressure loss as small as possible
- Pay attention to the mounting position of the flow sensor
- Min/max flow should be in the linear range of the selected flow sensor
- Clean the system at appropriate intervals
- Avoid electrical voltage spikes
- Incorrect wiring of power supply +, signal and ground will destroy the flow sensor
- Do not load electrical contacts mechanically
- Avoid moisture on the electrical contacts
- Avoid stray pick-up via the cable (Do not lay cables in parallel with high current loads)

Measurement Curve nano brass Ø1.2mm

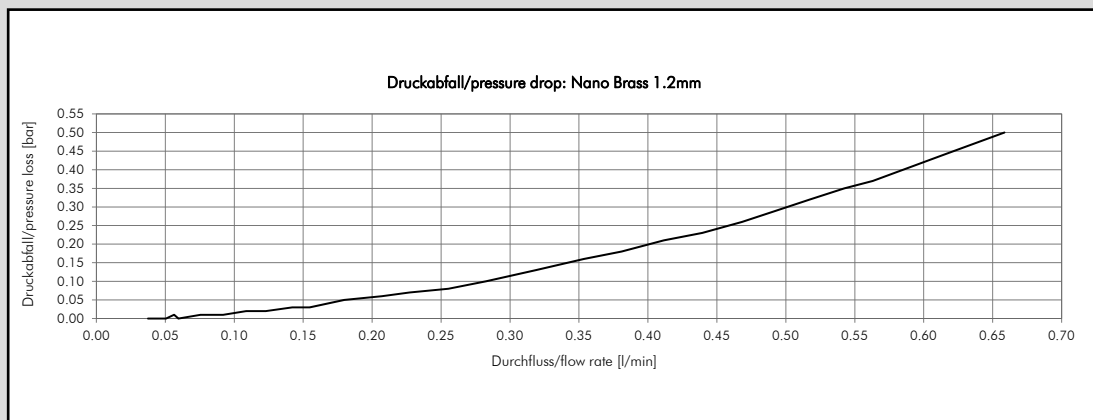
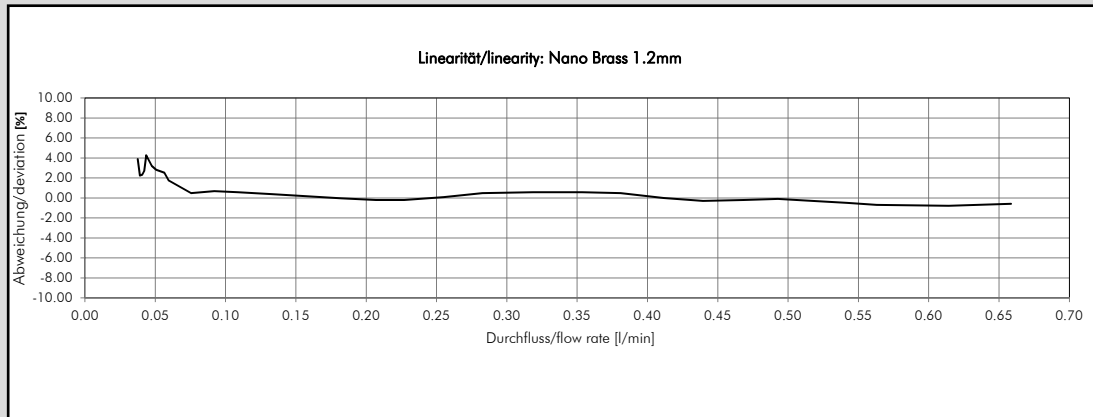

Medium: Water / Pressure: 3.5 bar

#9NB-1120/03 with pulse divider

Nozzle size	Pulses/Litre	ml/pulse	min. flow rate [l/min]	max. flow rate [l/min]	Pulse frequency [Hz] min/max
Ø 1.2 mm	1'944	0.51	0.05	0.50	~1.6 / 17

#9NB-1120/03A without pulse divider

Nozzle size	Pulses/Litre	ml/pulse	min. flow rate [l/min]	max. flow rate [l/min]	Pulse frequency [Hz] min/max
Ø 1.2 mm	31'100	0.032	0.05	0.50	~26 / 270

The values specified must be considered as approximate values.

The number of pulses per litre may differ depending on medium and installation.

We recommend to calibrate the number of pulses per litre in line with the complete installation.

MEASUREMENT TIPS

- Ensure that there is no fast-pulsatory movement of the media
- Ensure that there are no reverse pressure surges
- Ensure that there is no air in the system
- Keep the pressure loss as small as possible
- Pay attention to the mounting position of the flow sensor
- Min/max flow should be in the linear range of the selected flow sensor
- Clean the system at appropriate intervals
- Avoid electrical voltage spikes
- Incorrect wiring of power supply +, signal and ground will destroy the flow sensor
- Do not load electrical contacts mechanically
- Avoid moisture on the electrical contacts
- Avoid stray pick-up via the cable (Do not lay cables in parallel with high current loads)

Measurement Curve nano brass Ø1.4mm

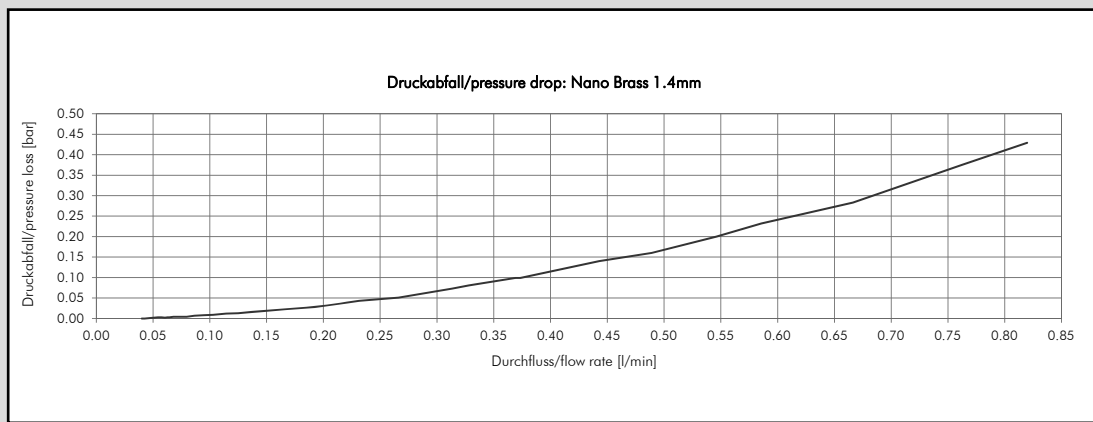
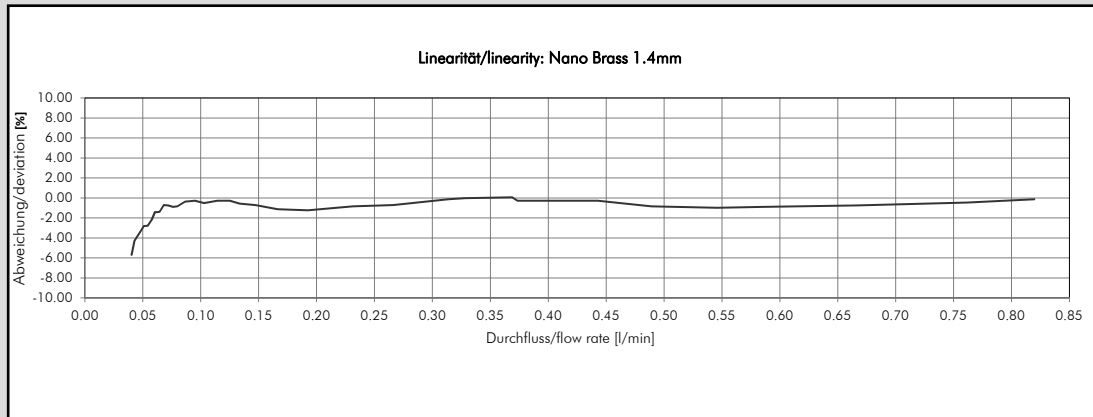

Medium: Water / Pressure: 3.5 bar

#9NB-1140/03 with pulse divider

Nozzle size	Pulses/ Litre	ml/pulse	min. flow rate [l/min]	max. flow rate [l/min]	Pulse frequency [Hz] min/max
Ø 1.4 mm	1'440	0.69	0.06	0.70	~1.6 / 17

#9NB-1140/03A without pulse divider

Nozzle size	Pulses/ Litre	ml/pulse	min. flow rate [l/min]	max. flow rate [l/min]	Pulse frequency [Hz] min/max
Ø 1.4 mm	23'040	0.043	0.06	0.70	~26 / 270

The values specified must be considered as approximate values.

The number of pulses per litre may differ depending on medium and installation.

We recommend to calibrate the number of pulses per litre in line with the complete installation.

MEASUREMENT TIPS

- Ensure that there is no fast-pulsatory movement of the media
- Ensure that there are no reverse pressure surges
- Ensure that there is no air in the system
- Keep the pressure loss as small as possible
- Pay attention to the mounting position of the flow sensor
- Min/max flow should be in the linear range of the selected flow sensor
- Clean the system at appropriate intervals
- Avoid electrical voltage spikes
- Incorrect wiring of power supply +, signal and ground will destroy the flow sensor
- Do not load electrical contacts mechanically
- Avoid moisture on the electrical contacts
- Avoid stray pick-up via the cable (Do not lay cables in parallel with high current loads)