

DATA SHEET

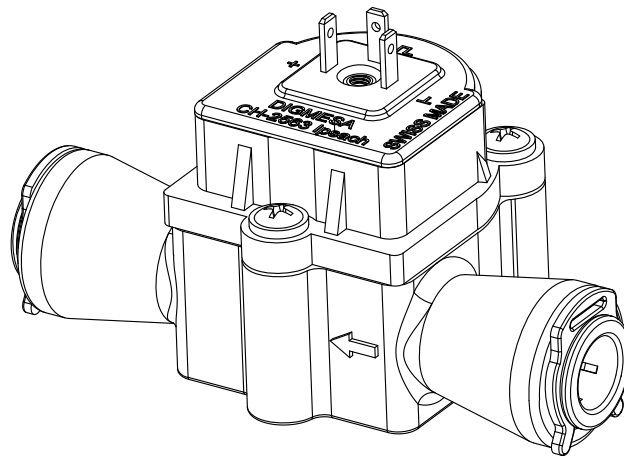

DIGMA SA[®]
CHOOSE THE ORIGINAL

FHKU John Guest 3/8"
Part number: 938-75xx/x01

DigmaSA AG, Keltenstrasse 31, CH-2563 Ipsach / Switzerland

Phone +41 (32) 332 77 77, Fax +41 (32) 332 77 88

www.digmaSA.com

Version 02 FHKU JG 3/8" 938-75xx/x01 GB Page 1-11

General Description

The FHKU Flowmeter is a general-purpose device; its working range can be individually defined according to its nozzle size. It is employed for measuring, regulating or metering and guarantees most precise measurement of fluid quantities. In addition, a pulse generator integrated into the flowmeter guarantees a practically unlimited useful life.

Special features: Linear inlet and outlet, compact design, great working range, depending on the nozzle diameter. Hose diameters from 3/8" (9.5mm) can be directly connected.

Approvals / Standards

EN55014-1:00+A1:01+A2:02, EN61000-6-3:01+A11:04, IEC61000-6-3:06(ed.2.0), EN61000-3-2:06, IEC61000-3-2:05(ed.3.0), EN61000-3-3:95+A1:01+A2:05, IEC61000-3-3:94+A1:01+A2:05(Cons.ed 1.2), EN55014-2:97+A1:01, EN61000-6-1:01, IEC61000-6-1:05(ed.2)



Material:

Housing: PBT 35%GF
 Bearing pin: Inox 1.4305
 Nozzle: Ø 1.0, 1.2, 2.0, 2.5mm
 PPS 40%GF
 Nozzle: Ø 3.0, 4.0mm Inox 1.4305
 Nozzle: Ø 5.6mm like housing
 O-ring: MVQ (Silikon)
 FPM (Viton) / EPDM on request
 Turbine: PVDF 2 Magnets
 Magnete: Ceramic Sr Fe O
 (in contact with the medium)
 Screws: PT-screws
 (Phillips cross recessed)

Technical data:

Flow rate: 0.041 - 15 l/min depending on the nozzle diameter
 Continuous operation: < 500 rpm
 Measuring accuracy: +/- 2.0%
 Repetition: < +/- 0.25%
 Temperature range: as shown on page 3
 Pressure range: as shown on page 3
 Mounting position: Horizontal *
 Nozzle size: Ø 1.0, 1.2, 2.0, 2.5, 3.0, 4.0, 5.6mm

Electrical connection ratings:

Power supply: +3.8 to +24 VDC
 Consumption: < 8 mA
 Signal connection: Open collector NPN
 Signal voltage: 0 VDC GND
 (saturation < 0.7 V)
 Signal load: max. 20 mA
 Leakage current: max. 10 µA
 Connections: 3Pin-AMP 2.8 x 0.8mm
 Signal: Square-wave output
 Duty Cycle: ~ 50%

Dimensions in mm:

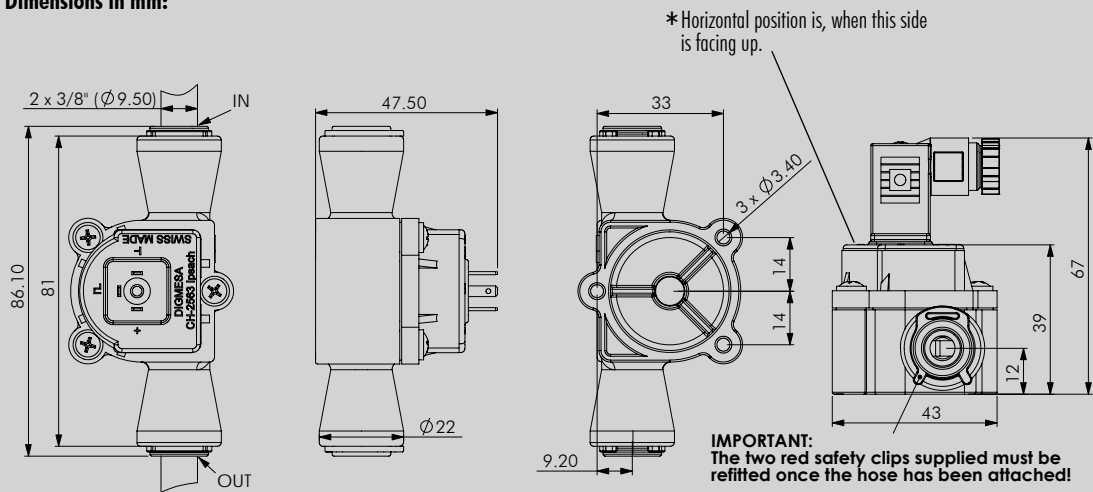

DIGMESA

Options: 3-pin valve connector
 Item number: 941-0010/3

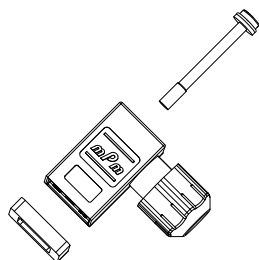

We reserve the right to make modifications in the interests of technical progress.

RESISTANCE

Special regulations which must be complied with by the flowmeter manufacturer apply to each country, e.g. CE, NSF, FDA and SK. The various media flowing through the flowmeter differ from application to application. You are advised to enquire with the medium manufacturer as to whether the entire installation and the flowmeter are resistant to the medium itself (see Material)!

ELECTRONIC

DIGMESA electronic circuitry is always designed for operation with DIGMESA flowmeters. Please note the following if connecting to other electronic circuitry:

- The flowmeter does not supply an output voltage but switches the signal terminal to 0 V ground (actuated) or leaves it open (non-actuated)
- There must be a pull-up resistor between power supply + and signal depending on electronic circuitry!

Version 02 FHKU JG 3/8" 938-75xx/01 GB Page 2-11

Technical Specification

Working Pressure and Temperature Range

Super Speedfit fittings are suitable for the following pressures and temperatures.

Temp.	Pressure	
	5/32" - 5/16" 4mm - 8mm	3/8" - 1/2" 10mm - 22mm
Air		
- 20°C	16 Bar	10 Bar
Potable Liquids and Air		
+1°C	16 Bar	10 Bar
+20°C	16 Bar	10 Bar
+65°C	10 Bar	7 Bar

Also suitable for vacuum

Depending on the tube used, under certain conditions fittings may be used at higher pressures and temperatures. Please refer to our Customer Services Department for guidance. Note 1 Bar = 14.5 PSIG.

Tube Types

Plastic Tube - Polyethylene, nylon and polyurethane conforming to the tolerances shown below. For soft tubing or thin wall tube we recommend the use of tube inserts.

Braided Tube - Use of Tube to Hose Stems listed on pages 5 and 12 is essential when using tube. Use of clamps to retain braided tube on barbs is recommended.

Metal Tube (soft) - Brass, copper or mild steel conforming to the tolerances below.

Metal Tube (hard) - We do not recommend Super Speedfit fittings for hard metal or chromium plated tubes.

For stainless steel and other polished metal tubes we recommend the use of Superseal fittings. These are shown on page 9 of this brochure. It is essential that outside diameters be free from score marks and that the tube be deburred before inserting the fitting.

Tube Tolerances

Super Speedfit fittings are offered for tubes with outside diameters to the following tolerances.

Size (inches)	5/32 - 3/16	1/4 - 1/2
Tolerance (inches)	+0.001 / -0.003	+0.001 / -0.004
Size (mm)	4mm - 5mm	6mm - 22mm
Tolerance (mm)	+0.05 / -0.07	+0.05 / -0.10

Installation and System Testing

Fittings and tube should be kept clean and undamaged before use. All tube and fittings installations must be pressure tested after installation to ensure system integrity before handing over to the final user. See also "How to make a connection".

1/4 Turn Valves

These valves have been designed to allow temporary servicing of downstream equipment and must only be used in the fully open or fully closed position. **DO NOT USE THESE VALVES:** In a partially open position to control flow; to provide a permanent termination; without tubing assembled or plugged (or threaded connections sealed, or as a tap or "faucet").

Chemicals

For use with chemicals or other potentially aggressive liquids, please refer to our Customer Services Department.

Super Speedfit fittings are not recommended for use with explosive gases, petroleum spirits, and other fuels or for central heating systems.

Collet Covers

Are available as additional security against removal of the tube or to provide a simple means of colour coding. The cover is offered in a range of six colours. Please see page 26 of this brochure.

Collet Covers

Are available as additional security against removal of the tube or to provide a simple means of colour coding. The cover is offered in a range of six colours. Please see page 26 of this brochure.

Food Quality

All the fittings in the brochure are produced in Food and Drug Administration (FDA) approved materials and are therefore recommended for food quality applications.

Maximum Torque Values for Plastic Threads BSP, BSPT & NPT.

Plastic threads are not generally as strong as brass threads. Customers and end users should be aware of this when choosing products for their applications. Overtightening of plastic threads will cause undue stress and eventual cracking and leakage. The maximum torque figures for BSP and BSPT threads used on John Guest fittings in mating threads conforming to the relevant BS or International thread standards are shown below.

	Threads		
	1/8 - 1/4	3/8 - 1/2	3/4
Max. Torque	1.5Nm	3.0Nm	4.0Nm

John Guest recommend OEM customers to consider replacing threaded ports with the more modern Cartridge Systems.

It is recommended that all installations are checked prior to use to determine that a seal has been made.

Maintenance and Replacement Intervals

John Guest products generally require little maintenance but as a minimum we recommend routine visual inspection. Frequency of visual inspection will depend on severity of application and risk of failure. If after visual inspection John Guest products appear damaged, cracked, charred, discoloured, heat distorted or corroded they should be replaced. Any product that is or appears to be leaking should be replaced.

Product life is affected by the severity of the application, the hostility of the working environment and contact with aggressive chemicals or liquids. It is therefore important that specific replacement intervals be considered by specifiers/users/customers based on previous service life or when failure could result in unacceptable downtime, damage or injury risk.

Cleaners and Sanitising of Acetal Fittings

The external surfaces of John Guest products must not come into contact with oxidising or acidic cleaners and sanitising agents, for example (but not limited to) those below pH 4, high in sodium hypochlorite level (bleach) or containing hydrogen peroxide. Our plastic material suppliers recommend ECOLAB Oasis 133 as a suitable cleaner for the external surfaces of acetal products manufactured by John Guest.

Several different methods exist for sanitising the internal surfaces of fluid systems, including sodium hypochlorite, hydrogen peroxide, chlorine dioxide or ozone. It is entirely the responsibility of the end user to determine if the chosen method is suitable for use with John Guest products over the planned working life of the system. However, to avoid unnecessary early failure, John Guest requires that the disinfection solution must be immediately flushed out at all draw off points with fresh, wholesome water at the end of the disinfection period. **The solution must not be left in the system.** Disinfection solutions must only come into contact with the internal (fluid carrying) surfaces of the system. If any other surfaces of a fitting come into contact with disinfection solution **the whole fitting must be replaced immediately.** Details of which products are made from Acetal are shown in our catalogues but generally John Guest products incorporating Acetal are designated by the part number prefix PI, PM, CI, CM and RM. Polypropylene fittings offer greater resistance to aggressive chemicals than Acetal fittings. Polypropylene does not have the same mechanical properties as Acetal and John Guest polypropylene fittings are generally designated by the part number prefix PP or PPM.

Side Loads

Fittings should not be subject to excessive side loads and they should not be used as support brackets. Tubing and fittings should be adequately supported to prevent excessive side loading.

Warranty

Whilst we give a warranty against defects in manufacture or materials, it is the responsibility of the specifier to ensure that fittings and related products are suitable for their application. The installation must be carried out correctly in accordance with our recommendations, complying with recognised codes of practice and relevant national standards, and be properly maintained. Please refer to our terms and conditions of sale.

www.johnguest.com

34

Important:

Secures the collet in its position to prevent an accidental disconnection of the tube.



We reserve the right to make modifications in the interests of technical progress.

Version 02 FHKU JG 3/8" 938-75xx/01 GB Page 3-11

Interface Connection: Examples Open Collector

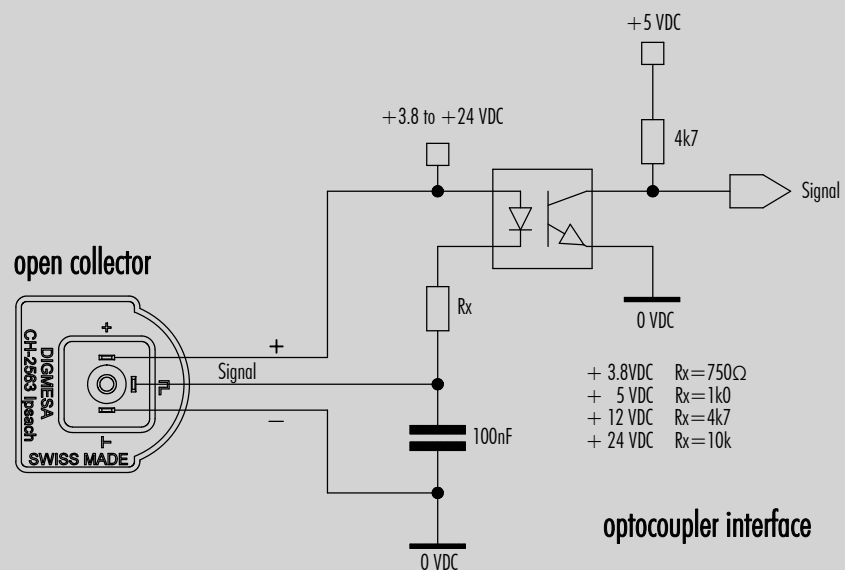
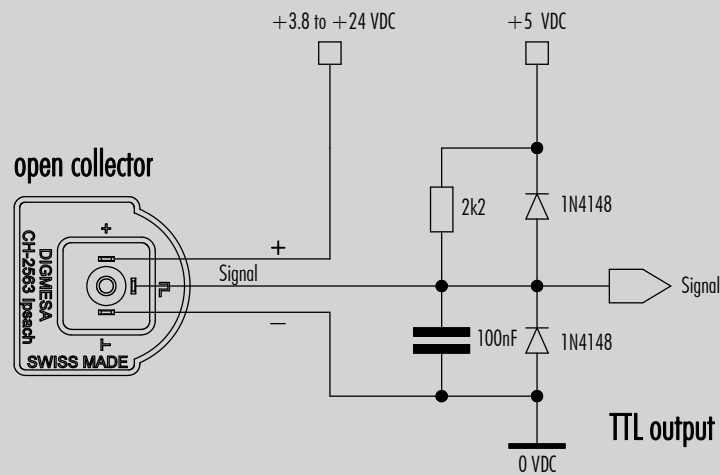
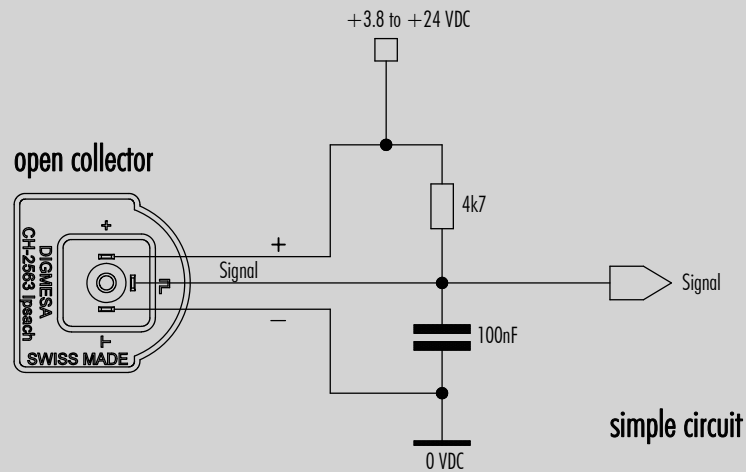

Measurement Curve FHKU Ø1.00mm (#938-7510/F01)

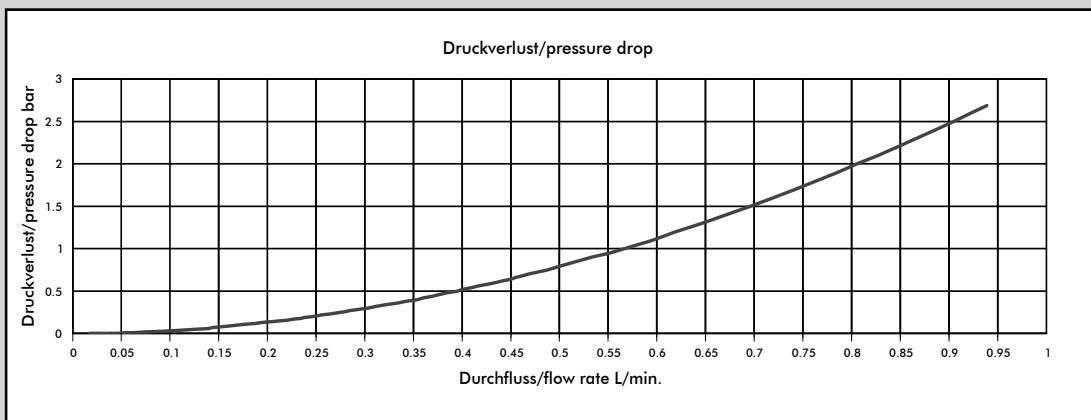
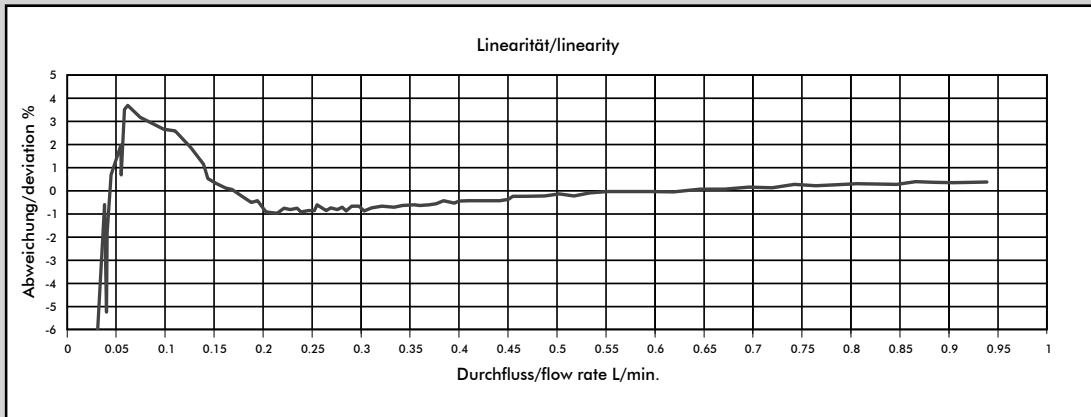

Getestet mit Wasser, max. Druck: 3.3 bar / Tested with water, max. pressure 3.3 bar

Nozzle size	Pulses/litre	g/pulse	min. flow rate in [litres/min] at linear start	max. flow rate in [litres/min]	Pressure loss in [bar]
Ø 1.00 mm	2063	0.48	0.041	0.56	1.0
Ø 1.20 mm	1700	0.59	0.050	0.82	1.0
Ø 2.00 mm	988	1.00	0.091	2.40	1.0
Ø 2.50 mm	760	1.31	0.150	3.74	1.0
Ø 3.00 mm	565	1.76	0.102	5.63	1.0
Ø 4.00 mm	381	2.62	0.123	8.38	0.8
Ø 5.60 mm	236	4.22	0.308	9.26	0.5

MEASUREMENT TIPS

- Ensure that there is no fast-pulsatory movement of the media
- Ensure that there are no reverse pressure surges
- Ensure that there is no air in the system
- Keep the pressure loss as small as possible
- Note the mounting position of the flowmeter
- Min/max flow should be in the linear range of the selected flowmeter
- Clean the system at appropriate intervals
- Avoid electrical current peaks
- Incorrect cabling of power supply +, signal and ground will destroy the flowmeter
- Do not mechanically load electrical contacts
- Avoid moisture on the electrical contacts
- Avoid stray pick-up via the cable (Do not lay cables in parallel with high current loads)

The values specified must be considered as approximate values.

The number of pulses per litre may differ depending on medium and installation.

We recommend to calibrate the number of pulses per litre in line with the complete installation.

Measurement Curve FHKU Ø1.20mm (#938-7512/F01)

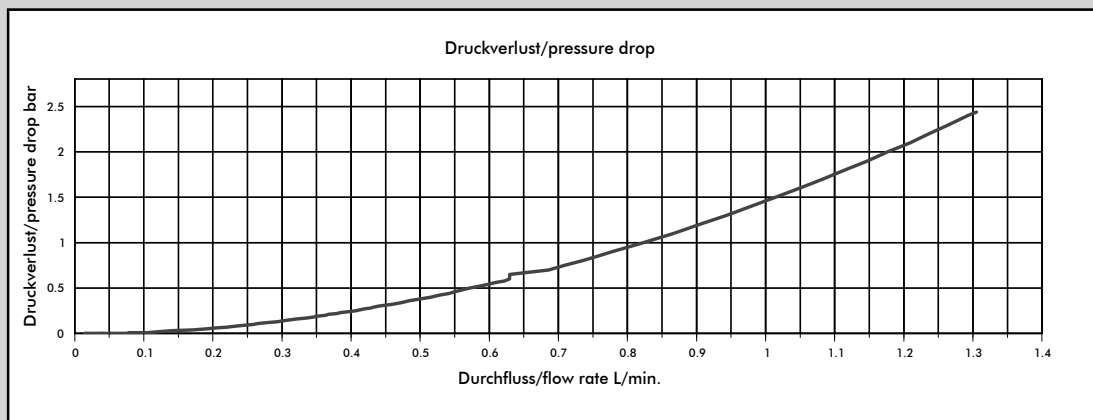
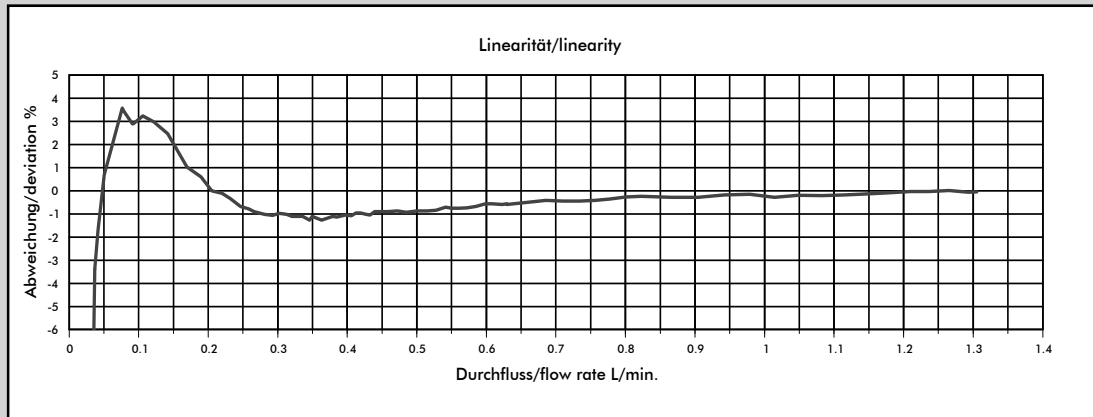

Getestet mit Wasser, max. Druck: 3.3 bar / Tested with water, max. pressure 3.3 bar

Nozzle size	Pulses/litre	g/pulse	min. flow rate in [litres/min] at linear start	max. flow rate in [litres/min]	Pressure loss in [bar]
Ø 1.00 mm	2063	0.48	0.041	0.56	1.0
Ø 1.20 mm	1700	0.59	0.050	0.82	1.0
Ø 2.00 mm	988	1.00	0.091	2.40	1.0
Ø 2.50 mm	760	1.31	0.150	3.74	1.0
Ø 3.00 mm	565	1.76	0.102	5.63	1.0
Ø 4.00 mm	381	2.62	0.123	8.38	0.8
Ø 5.60 mm	236	4.22	0.308	9.26	0.5

MEASUREMENT TIPS

- Ensure that there is no fast-pulsatory movement of the media
- Ensure that there are no reverse pressure surges
- Ensure that there is no air in the system
- Keep the pressure loss as small as possible
- Note the mounting position of the flowmeter
- Min/max flow should be in the linear range of the selected flowmeter
- Clean the system at appropriate intervals
- Avoid electrical current peaks
- Incorrect cabling of power supply +, signal and ground will destroy the flowmeter
- Do not mechanically load electrical contacts
- Avoid moisture on the electrical contacts
- Avoid stray pick-up via the cable (Do not lay cables in parallel with high current loads)

The values specified must be considered as approximate values.

The number of pulses per litre may differ depending on medium and installation.

We recommend to calibrate the number of pulses per litre in line with the complete installation.

Measurement Curve FHKU Ø2.00mm (#938-7520/F01)

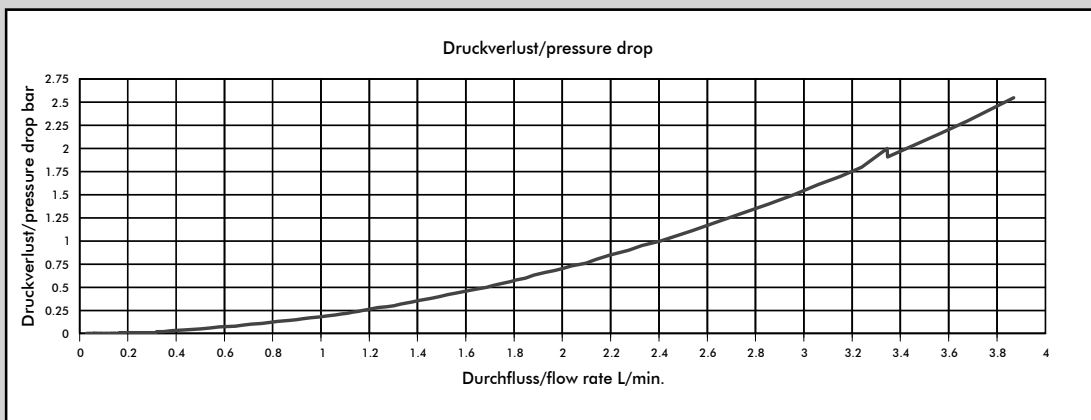
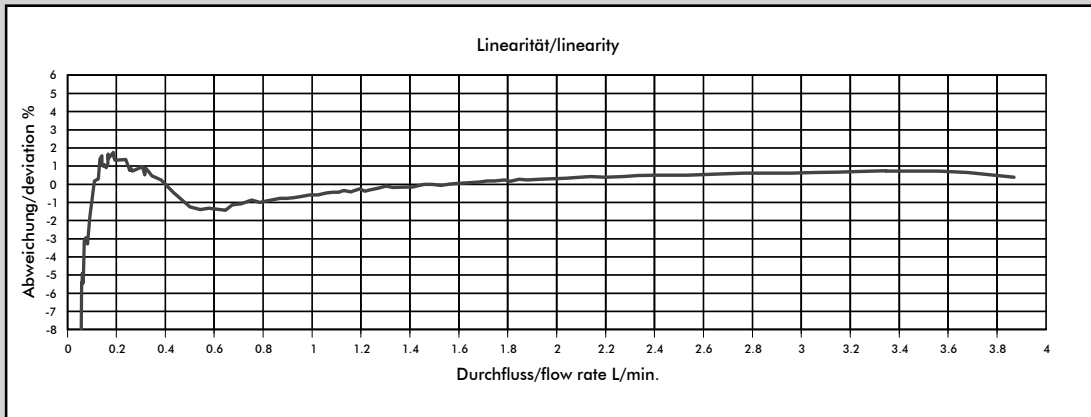

Getestet mit Wasser, max. Druck: 3.3 bar / Tested with water, max. pressure 3.3 bar

Nozzle size	Pulses/litre	g/pulse	min. flow rate in [litres/min] at linear start	max. flow rate in [litres/min]	Pressure loss in [bar]
Ø 1.00 mm	2063	0.48	0.041	0.56	1.0
Ø 1.20 mm	1700	0.59	0.050	0.82	1.0
Ø 2.00 mm	988	1.00	0.091	2.40	1.0
Ø 2.50 mm	760	1.31	0.150	3.74	1.0
Ø 3.00 mm	565	1.76	0.102	5.63	1.0
Ø 4.00 mm	381	2.62	0.123	8.38	0.8
Ø 5.60 mm	236	4.22	0.308	9.26	0.5

The values specified must be considered as approximate values.

The number of pulses per litre may differ depending on medium and installation.

We recommend to calibrate the number of pulses per litre in line with the complete installation.

MEASUREMENT TIPS

- Ensure that there is no fast-pulsatory movement of the media
- Ensure that there are no reverse pressure surges
- Ensure that there is no air in the system
- Keep the pressure loss as small as possible
- Note the mounting position of the flowmeter
- Min/max flow should be in the linear range of the selected flowmeter
- Clean the system at appropriate intervals
- Avoid electrical current peaks
- Incorrect cabling of power supply +, signal and ground will destroy the flowmeter
- Do not mechanically load electrical contacts
- Avoid moisture on the electrical contacts
- Avoid stray pick-up via the cable (Do not lay cables in parallel with high current loads)

Measurement Curve FHKU Ø2.50mm (#938-7525/F01)

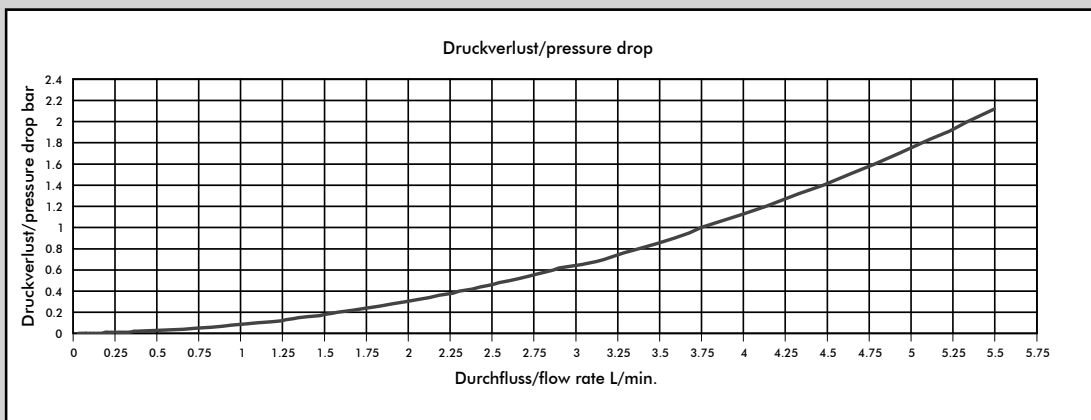
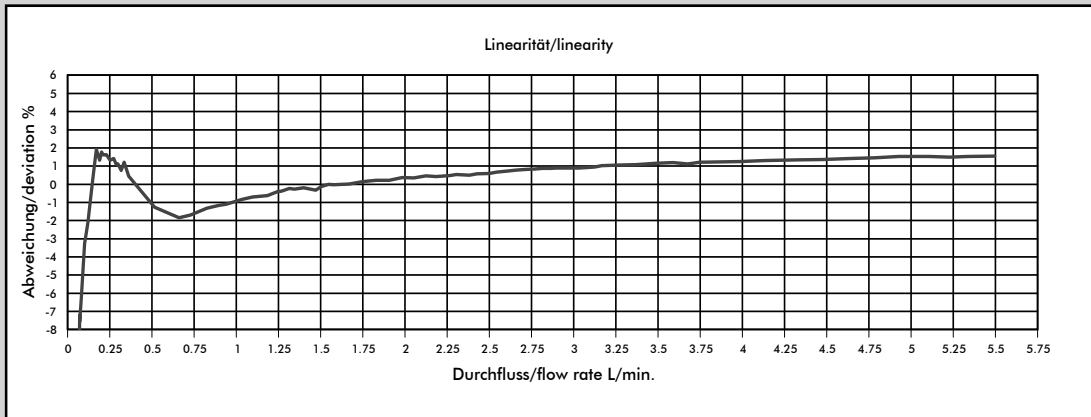

Getestet mit Wasser, max. Druck: 3.3 bar / Tested with water, max. pressure 3.3 bar

Nozzle size	Pulses/litre	g/pulse	min. flow rate in [litres/min] at linear start	max. flow rate in [litres/min]	Pressure loss in [bar]
Ø 1.00 mm	2063	0.48	0.041	0.56	1.0
Ø 1.20 mm	1700	0.59	0.050	0.82	1.0
Ø 2.00 mm	988	1.00	0.091	2.40	1.0
Ø 2.50 mm	760	1.31	0.150	3.74	1.0
Ø 3.00 mm	565	1.76	0.102	5.63	1.0
Ø 4.00 mm	381	2.62	0.123	8.38	0.8
Ø 5.60 mm	236	4.22	0.308	9.26	0.5

MEASUREMENT TIPS

- Ensure that there is no fast-pulsatory movement of the media
- Ensure that there are no reverse pressure surges
- Ensure that there is no air in the system
- Keep the pressure loss as small as possible
- Note the mounting position of the flowmeter
- Min/max flow should be in the linear range of the selected flowmeter
- Clean the system at appropriate intervals
- Avoid electrical current peaks
- Incorrect cabling of power supply +, signal and ground will destroy the flowmeter
- Do not mechanically load electrical contacts
- Avoid moisture on the electrical contacts
- Avoid stray pick-up via the cable (Do not lay cables in parallel with high current loads)

The values specified must be considered as approximate values.

The number of pulses per litre may differ depending on medium and installation.

We recommend to calibrate the number of pulses per litre in line with the complete installation.

Measurement Curve FHKU Ø3.00mm (#938-7530/01)

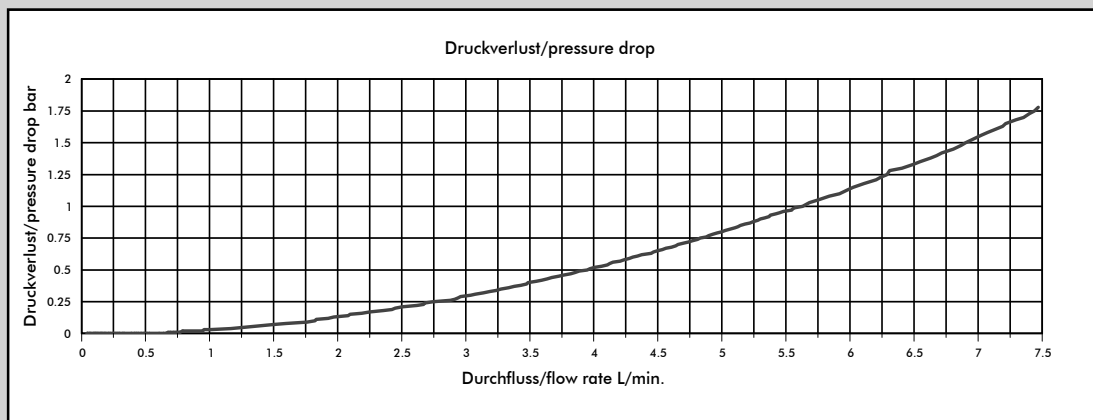
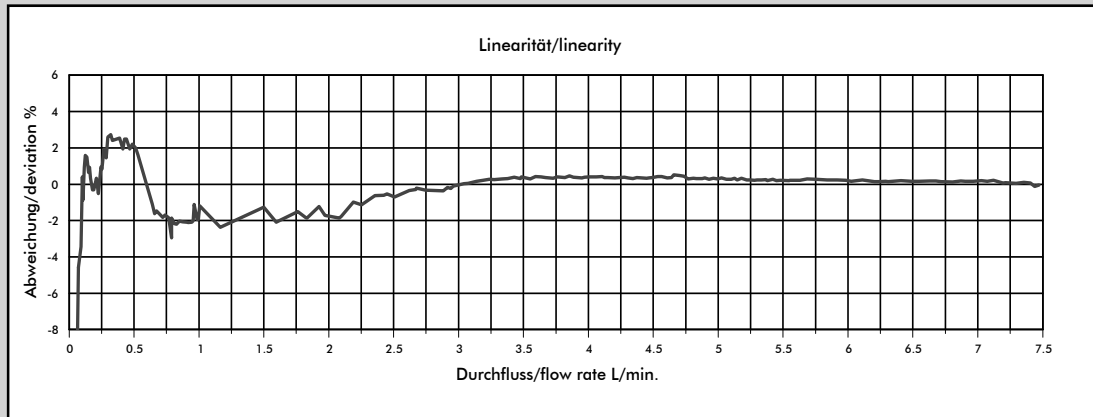

Getestet mit Wasser, max. Druck: 3.3 bar / Tested with water, max. pressure 3.3 bar

Nozzle size	Pulses/litre	g/pulse	min. flow rate in [litres/min] at linear start	max. flow rate in [litres/min]	Pressure loss in [bar]
Ø 1.00 mm	2063	0.48	0.041	0.56	1.0
Ø 1.20 mm	1700	0.59	0.050	0.82	1.0
Ø 2.00 mm	988	1.00	0.091	2.40	1.0
Ø 2.50 mm	760	1.31	0.150	3.74	1.0
Ø 3.00 mm	565	1.76	0.102	5.63	1.0
Ø 4.00 mm	381	2.62	0.123	8.38	0.8
Ø 5.60 mm	236	4.22	0.308	9.26	0.5

MEASUREMENT TIPS

- Ensure that there is no fast-pulsatory movement of the media
- Ensure that there are no reverse pressure surges
- Ensure that there is no air in the system
- Keep the pressure loss as small as possible
- Note the mounting position of the flowmeter
- Min/max flow should be in the linear range of the selected flowmeter
- Clean the system at appropriate intervals
- Avoid electrical current peaks
- Incorrect cabling of power supply +, signal and ground will destroy the flowmeter
- Do not mechanically load electrical contacts
- Avoid moisture on the electrical contacts
- Avoid stray pick-up via the cable (Do not lay cables in parallel with high current loads)

The values specified must be considered as approximate values.

The number of pulses per litre may differ depending on medium and installation.

We recommend to calibrate the number of pulses per litre in line with the complete installation.

Measurement Curve FHKU Ø4.00mm (#938-7540/01)

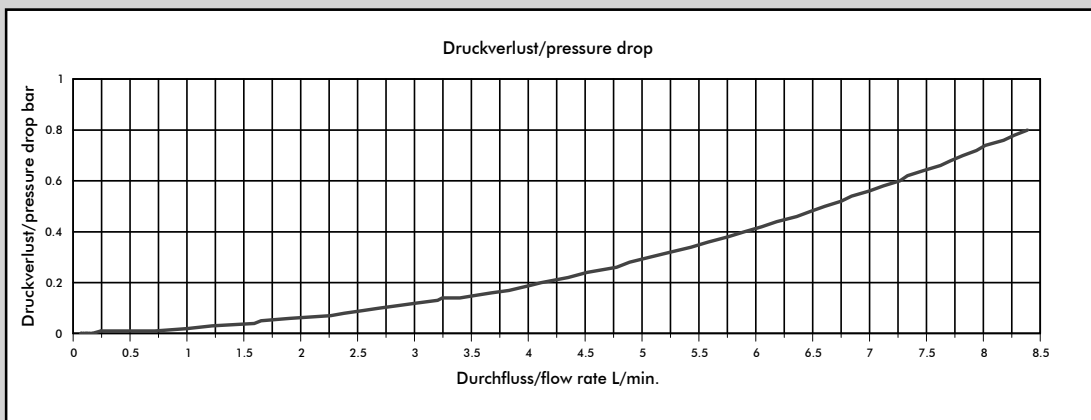
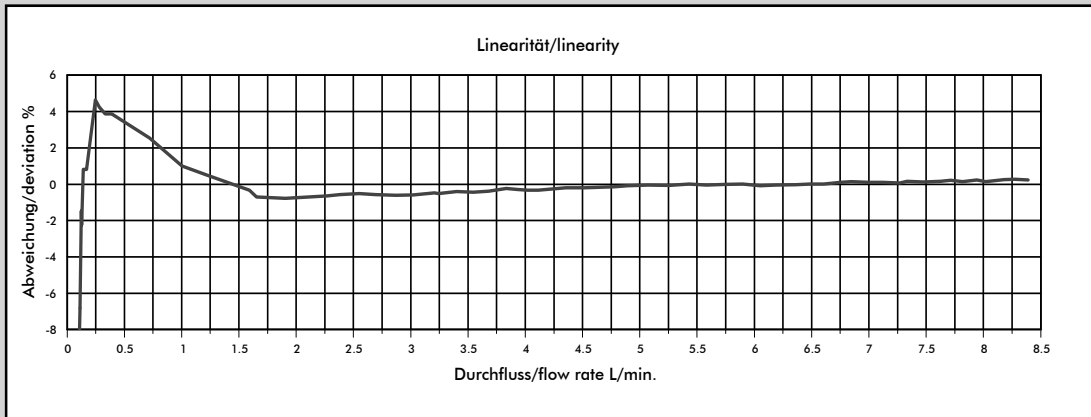

Getestet mit Wasser, max. Druck: 3.3 bar / Tested with water, max. pressure 3.3 bar

Nozzle size	Pulses/litre	g/pulse	min. flow rate in [litres/min] at linear start	max. flow rate in [litres/min]	Pressure loss in [bar]
Ø 1.00 mm	2063	0.48	0.041	0.56	1.0
Ø 1.20 mm	1700	0.59	0.050	0.82	1.0
Ø 2.00 mm	988	1.00	0.091	2.40	1.0
Ø 2.50 mm	760	1.31	0.150	3.74	1.0
Ø 3.00 mm	565	1.76	0.102	5.63	1.0
Ø 4.00 mm	381	2.62	0.123	8.38	0.8
Ø 5.60 mm	236	4.22	0.308	9.26	0.5

MEASUREMENT TIPS

- Ensure that there is no fast-pulsatory movement of the media
- Ensure that there are no reverse pressure surges
- Ensure that there is no air in the system
- Keep the pressure loss as small as possible
- Note the mounting position of the flowmeter
- Min/max flow should be in the linear range of the selected flowmeter
- Clean the system at appropriate intervals
- Avoid electrical current peaks
- Incorrect cabling of power supply +, signal and ground will destroy the flowmeter
- Do not mechanically load electrical contacts
- Avoid moisture on the electrical contacts
- Avoid stray pick-up via the cable (Do not lay cables in parallel with high current loads)

The values specified must be considered as approximate values.

The number of pulses per litre may differ depending on medium and installation.

We recommend to calibrate the number of pulses per litre in line with the complete installation.

Measurement Curve FHKU Ø5.60mm (#938-7556/01)

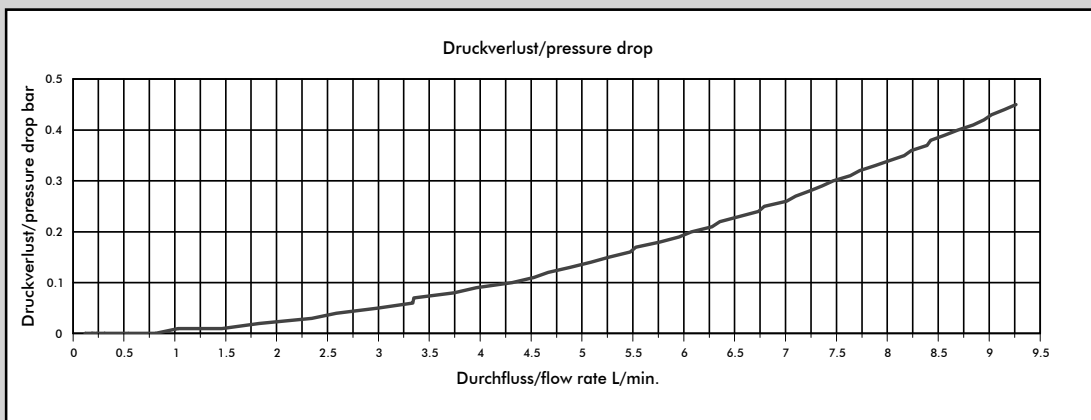
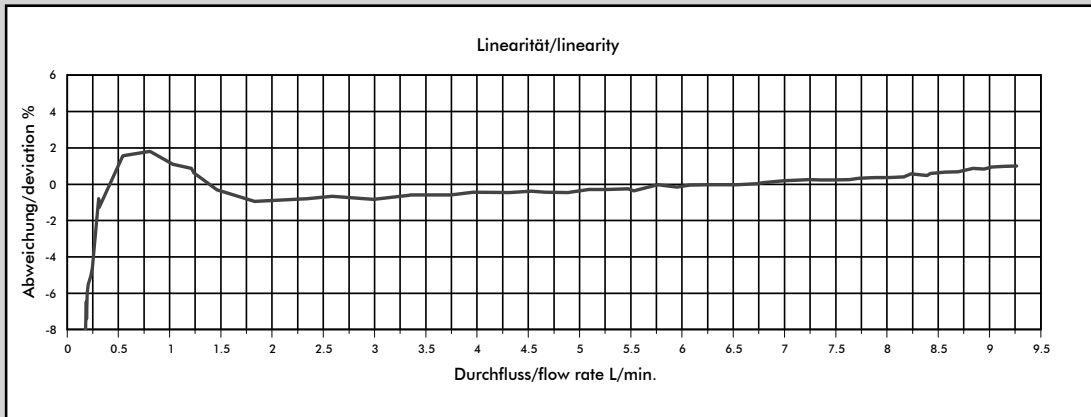

Getestet mit Wasser, max. Druck: 3.3 bar / Tested with water, max. pressure 3.3 bar

Nozzle size	Pulses/litre	g/pulse	min. flow rate in [litres/min] at linear start	max. flow rate in [litres/min]	Pressure loss in [bar]
Ø 1.00 mm	2063	0.48	0.041	0.56	1.0
Ø 1.20 mm	1700	0.59	0.050	0.82	1.0
Ø 2.00 mm	988	1.00	0.091	2.40	1.0
Ø 2.50 mm	760	1.31	0.150	3.74	1.0
Ø 3.00 mm	565	1.76	0.102	5.63	1.0
Ø 4.00 mm	381	2.62	0.123	8.38	0.8
Ø 5.60 mm	236	4.22	0.308	9.26	0.5

MEASUREMENT TIPS

- Ensure that there is no fast-pulsatory movement of the media
- Ensure that there are no reverse pressure surges
- Ensure that there is no air in the system
- Keep the pressure loss as small as possible
- Note the mounting position of the flowmeter
- Min/max flow should be in the linear range of the selected flowmeter
- Clean the system at appropriate intervals
- Avoid electrical current peaks
- Incorrect cabling of power supply +, signal and ground will destroy the flowmeter
- Do not mechanically load electrical contacts
- Avoid moisture on the electrical contacts
- Avoid stray pick-up via the cable (Do not lay cables in parallel with high current loads)

The values specified must be considered as approximate values.

The number of pulses per litre may differ depending on medium and installation.

We recommend to calibrate the number of pulses per litre in line with the complete installation.