

DATA SHEET

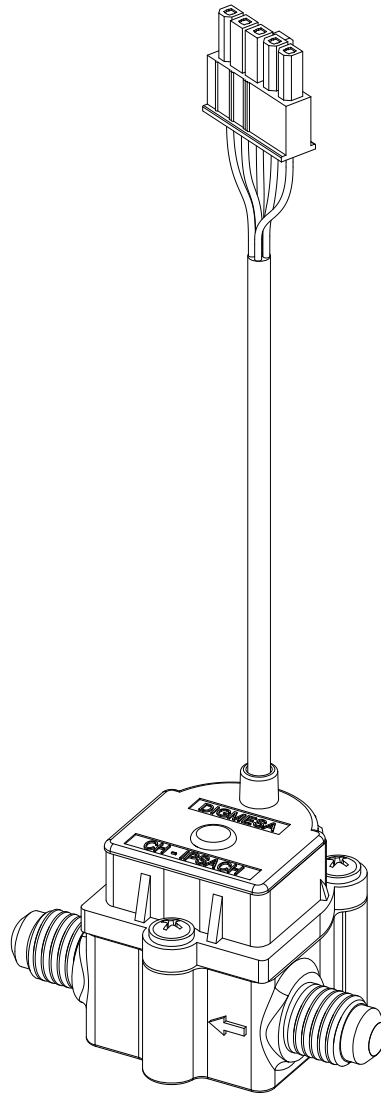

DIGIMESA[®]
CHOOSE THE ORIGINAL

FHKU BSF 1/2"-16 CombiSensor digital
Part number: 938-25xx/xTL02

Digimesa AG, Keltenstrasse 31, CH-2563 Ipsach / Switzerland
Phone +41 (32) 332 77 77, Fax +41 (32) 332 77 88

www.digimesa.com Version 01 FHKU BSF 1/2"-16 CombiSensor digital 938-25xx/xTL02 GB Page 1-12

General Description

The CombiSensor has been designed for all applications where Flow, Temperature and Conductivity must be measured in a very compact form. The CombiSensor calculates the temperature compensation of the conductivity value, based on the measured temperature and a compensation factor 2.25% per °C. The conductivity measurement value is therefore "temperature-compensated".

The "CombiSensor digital" comes with a RS-485 Interface (Modbus protocol). The configuration of the CombiSensor can be modified with standard MODBUS functions. The device is adequate for the waterfilter industry (e.g. compact RO equipment).

Approvals / Standards

EN55014-1:00+A1:01+A2:02, EN61000-6-3:01+A11:04, IEC61000-6-3:06(ed.2.0), EN61000-3-2:06, IEC61000-3-2:05(ed.3.0), EN61000-3-3:95+A1:01+A2:05, IEC61000-3-3:94+A1:01+A2:05(Cons.ed 1.2), EN55014-2:97+A1:01, EN61000-6-1:01, IEC61000-6-1:05(ed.2)



Material:

Housing:	PBT 35%GF
Bearing pin:	Inox 1.4305
Probes:	Temperature Inox 1.4598 Conductivity Inox 1.4598
Nozzle:	Ø 1.0, 1.2, 2.0, 2.5mm PPS 40%GF
Nozzle:	Ø 3.0, 4.0mm Inox 1.4305
Nozzle:	Ø 5.6mm like housing
O-ring:	MVQ (Silikon) FPM (Viton) / EPDM on request
Turbine:	PVDF 2 Magnets
Magnete:	Ceramic Sr Fe O (in contact with the medium)
Screws:	PT-screws (Phillips cross recessed)

Measurement characteristics:

Flow rate:	0.041 - 15 l/min depending on the nozzle diameter
Nozzle size:	Ø 1.0, 1.2, 2.0, 2.5, 3.0, 4.0, 5.6mm
Continuous operation:	< 500 rpm
Measuring accuracy:	+/- 2.0%
Repetition:	< +/- 0.25%
Conductivity:	0 - 20'000 µS/cm
Measuring accuracy:	± 3%
Response time:	0.5 sec.
Temperature:	0°C to +65 °C
Measuring accuracy:	± 0.5 °C (under flow condition)
Response time probe:	7 sec.

Electrical connection ratings:

Power supply:	+5VDC to +24VDC (+/-10%)
Consumption:	max. 30mA
Pulse output:	Open collector NPN
Signal load:	max. 20 mA
Serial port:	RS-485 Half Duplex (2-wire) (9600 baud, even parity, 8 bits binary, 1 stop bit)
Communication protocol:	Modbus RTU
Cable:	5-Pol Cable 5 x 0.14mm²
Connector:	Molex Mini-Fit Jr. UL94V-0

Technical data:

Temperature range:	0°C to +65°C 32°F to 149°F
Pressure range:	20 bar at 20°C 290 psi /68°F
Mounting position:	Horizontal *

Dimensions in mm:

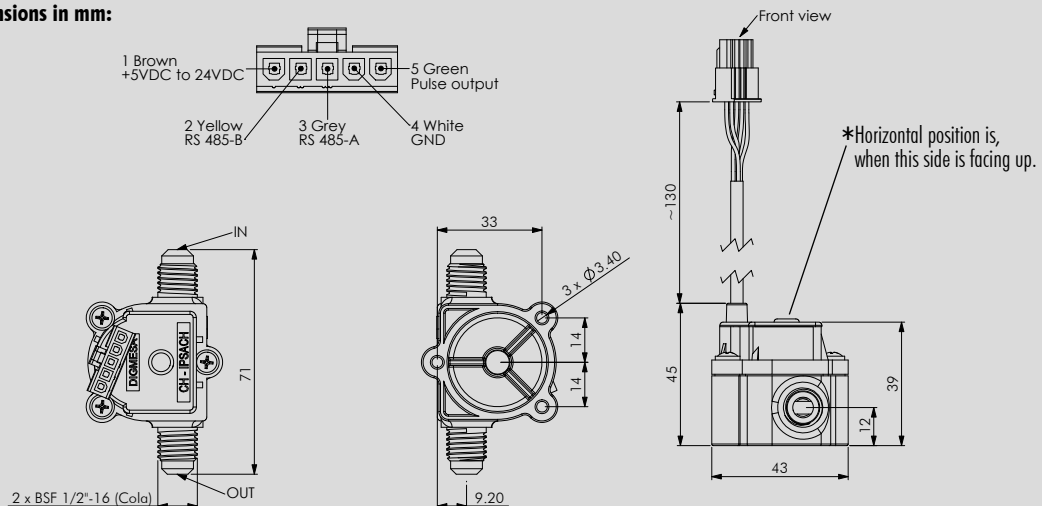

CABLE PINOUT

Cable color	Description
Brown	+5VDC to +24VDC
White	GND (Sensor Ground)
Grey	RS 485A
Yellow	RS 485B
Green	Pulse output (Open collector NPN)

MEASUREMENT

The flow measurement may differ depending on medium and installation. We recommend to calibrate the number of pulses per liter in line with the complete installation"

RESISTANCE

Special regulations which must be complied with by the flowmeter manufacturer apply to each country, e.g. CE, NSF, FDA and SK. The various media flowing through the flowmeter differ from application to application. You are advised to enquire with the medium manufacturer as to whether the entire installation and the flowmeter are resistant to the medium itself (see Material)!

Modbus Register Map

Input Registers (Read only):

Read out corresponding registers with function code 4 (0x04) (Read Input Registers).

Sensor data registers:

Input Register	Address dec	Address hex	Description	Data type	Ratio	Unit	Value range	Example	Remarks
30001	0	0x0000	Volume	16 Bit unsigned integer	1:1	[L]	0-65535	100 => 100 Liter since last power up	Not stored in non volatile memory! The same volume is also present in holding register 40001 Volume , for performing a reset.
30002	1	0x0001	Flow rate	16 Bit unsigned integer	1:1	[ml/min]	0-65535	500 => 500ml/min	Actual flowrate
30003	2	0x0002	Conductivity	16 Bit unsigned integer	1:1	[μ S/cm]	0-65535	10000 => 10000 μ S/cm	Compensated if holding register 40006 Temperature compensation is set (Default)
30004	3	0x0003	Temperature	16 Bit unsigned integer	10:1	[$^{\circ}$ C]	0-1250	276 => 27.6 $^{\circ}$ C	value 0xffff => temp sensor failure
30005	4	0x0004	Conductivity uncompensated	16 Bit unsigned integer	1:1	[μ S/cm]	0-65535	10000 => 10000 μ S/cm	Always uncompensated conductivity.

Sensor software number registers:

Input Register	Address dec	Address hex	Description	Data type	Ratio	Unit	Value range	Example	Remarks
30101	100	0x0064	SW Version number	16 Bit unsigned integer	1:1	---	0-65535	0x0103 => V1.3	representating 639-9076/ V1.3
30102	101	0x0065	SW number low	16 Bit unsigned integer	1:1	---	0-65535	9076 (low number)	representating 639- 9076 /V1.3
30103	102	0x0066	SW number high	16 Bit unsigned integer	1:1	---	0-65535	639 (high number)	representating 639 -9076/V1.3

DIGMESA

Holding Registers (Read/Write):

Read out corresponding registers with function code 3 (0x03) (Read Holding Registers)

Write corresponding registers with function code 6 (0x06) (Write Single Register).

Sensor data registers:

Holding Register	Address dec	Address hex	Description	Data type	Ratio	Unit	Value range	Default	Remarks
40001	0	0x0000	Volume	16 Bit unsigned integer	1:1	[L]	0-65535	0 => 0 Liter	Read and writable volume (Same as Input Register 30001 Volume). By writing e.g. a value of 0 the volume can be resetted. Not stored in non volatile memory!

Sensor settings registers:

Holding Register	Address dec	Address hex	Description	Data type	Ratio	Unit	Value range	Default	Remarks
40101	100	0x0064	Offset Temperature	16 Bit signed integer	10:1	[°C]	-32768 to +32767	0	A value of e.g. -15 lowers the temperature by 1.5 °C.
40102	101	0x0065	Offset Conductivity	16 Bit signed integer	10:1	[µS/cm]	-32768 to +32767	0	A value of e.g. +43 increases the conductivity by 4.3 uS/cm.
40103	102	0x0066	Slope Conductivity	16 Bit unsigned integer	1:1	---	0-65535	10000	Gain calibration factor
40104	103	0x0067	Reference Temperature	16 Bit unsigned integer	1:1	---	0: 20 °C 1: 25 °C	1: 25 °C	1: 25 °C
40105	104	0x0068	Temperature compensation factor	16 Bit unsigned integer	100:1	[%/°C]	0-65535	225	A factor of e.g. 225 compensates linearly the conductivity by 2.25%/°C around the reference temperature.
40106	105	0x0069	Temperature compensation	16 Bit unsigned integer	1:1	---	0: Temp. comp OFF 1: Temp. Comp ON	1: Temp. Comp ON	If temperature compensation is ON, the conductivity in input register 30003 Conductivity is temperature compensated.
40107	106	0x006A	Pulses per liter	16 Bit unsigned integer	1:1	[#/l]	20-65535	see impuls value in the data sheet	Specific to sensor type and nozzle size.
40108	107	0x006B	Pulse averaging (Digital filter)	16 Bit unsigned integer	1:1	---	0: 1 Pulse 1: 2 Pulses 2: 4 Pulses 3: 8 Pulses 4: 16 Pulses 5: 32 Pulses	0: 1 Pulse	Pulse averaging for flow calculation, used for the Flow in input register 30001 Flow rate .
40109	108	0x006C	Slave ID	16 Bit unsigned integer	1:1	---	1-247	1	For connecting more than one sensor to the same bus individual slave ID's can be set.
40110	109	0x006D	Response Delay	16 Bit unsigned integer	1:1	[baud cycles]	0-1000	340	Delay in baud cycles after the sensor (slave) responds to the master after reception of the request. This value is depending on the master UART and is for compatibility purposes.

CONNECTION

Typical Modbus connection diagram

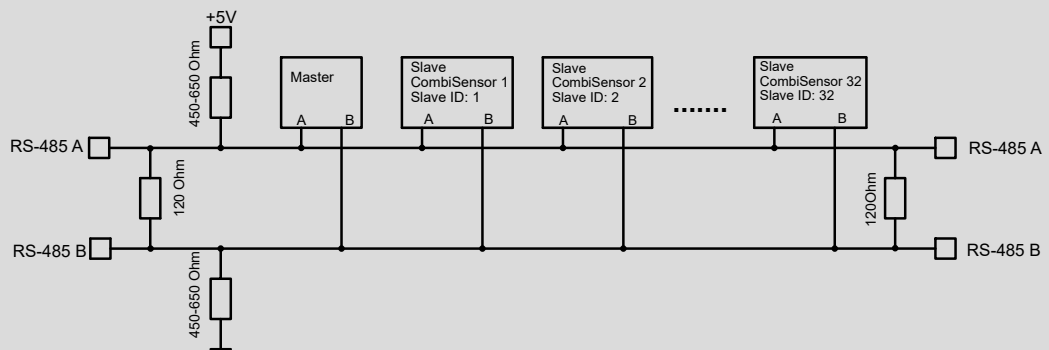

Notes:

- In addition the sensor GND can be connected between Master and slaves for limiting common mode voltages.
- Pull-Up/Pull-Down resistors of 450-650 Ohm recommended on RS485-A/RS485-B line.
- One pair of termination resistors of 120 Ohm recommended at each conductor end.
- The CombiSensor has no Pull-Up/Pull-Down resistors and no termination resistor integrated.

Typical Pulse output diagram:

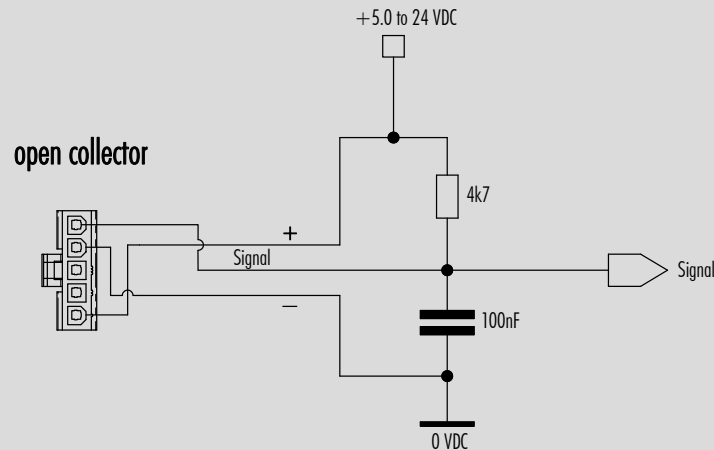

MEASUREMENT CONDUCTIVITY/TEMPERATURE TIPS

- Air bubbles in the sensor can deteriorate conductivity measurement values. Make sure you did well evacuate the air from the sensor.
- For measuring accurate temperature compensated conductivity, flowing medium guarantees optimal temperature condition for the probe.
- The CombiSensor is factory calibrated. If needed, further adjustment can be made by writing to register 40102 (Offset Conductivity) and 40103 (Slope Conductivity).
- The temperature can be adjusted by writing to register 40101 (Offset temperature).

Measurement Curve FHKU Ø1.00mm (#938-2510/FTL02)

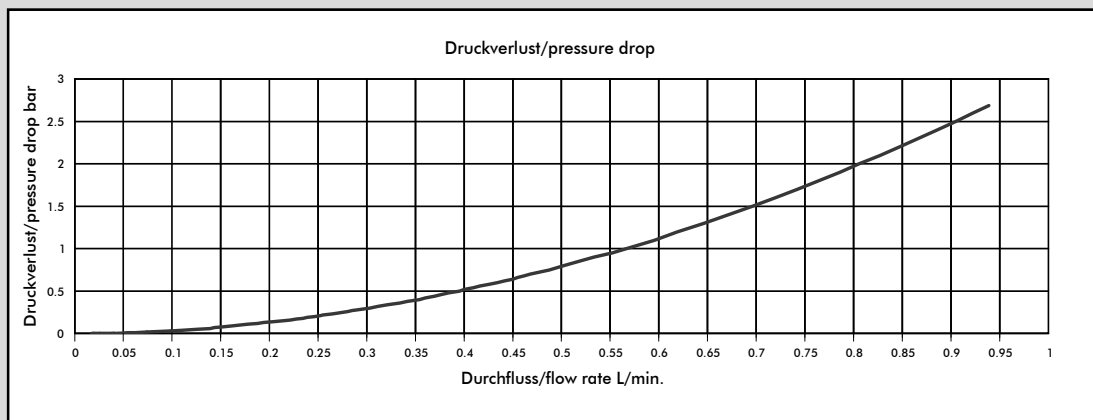
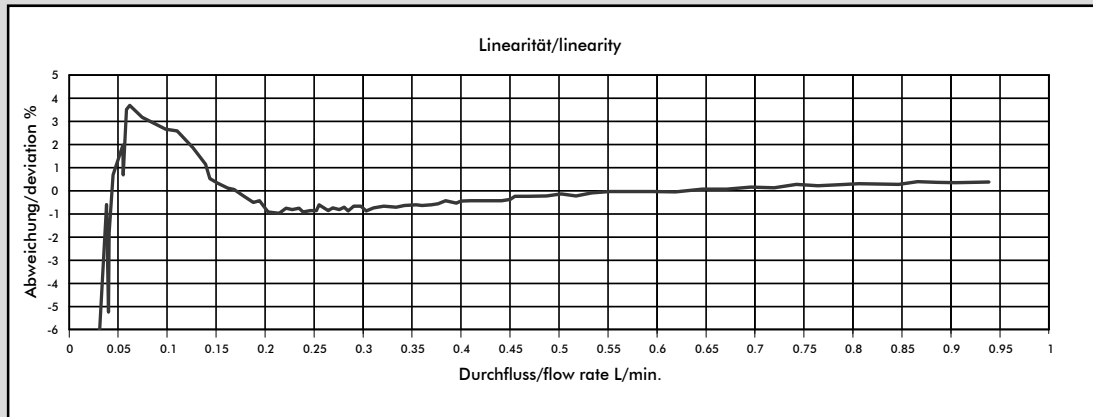

Getestet mit Wasser, max. Druck: 3.3 bar / Tested with water, max. pressure 3.3 bar

Nozzle size	Pulses/litre	g/pulse	min. flow rate in [litres/min] at linear start	max. flow rate in [litres/min]	Pressure loss in [bar]
Ø 1.00 mm	2063	0.48	0.041	0.56	1.0
Ø 1.20 mm	1700	0.59	0.050	0.82	1.0
Ø 2.00 mm	988	1.00	0.091	2.40	1.0
Ø 2.50 mm	760	1.31	0.150	3.74	1.0
Ø 3.00 mm	565	1.76	0.102	5.63	1.0
Ø 4.00 mm	381	2.62	0.123	8.38	0.8
Ø 5.60 mm	236	4.22	0.308	9.26	0.5

MEASUREMENT TIPS

- Ensure that there is no fast-pulsatory movement of the media
- Ensure that there are no reverse pressure surges
- Ensure that there is no air in the system
- Keep the pressure loss as small as possible
- Note the mounting position of the flowmeter
- Min/max flow should be in the linear range of the selected flowmeter
- Clean the system at appropriate intervals
- Avoid electrical current peaks
- Incorrect cabling of power supply +, signal and ground will destroy the flowmeter
- Do not mechanically load electrical contacts
- Avoid moisture on the electrical contacts
- Avoid stray pick-up via the cable (Do not lay cables in parallel with high current loads)

The values specified must be considered as approximate values.

The number of pulses per litre may differ depending on medium and installation.

We recommend to calibrate the number of pulses per litre in line with the complete installation.

Measurement Curve FHKU Ø1.20mm (#938-2512/FTL02)

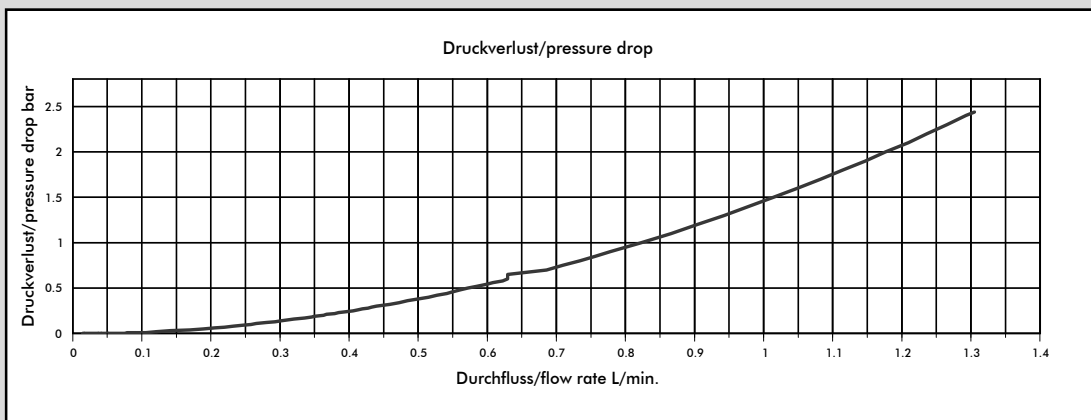
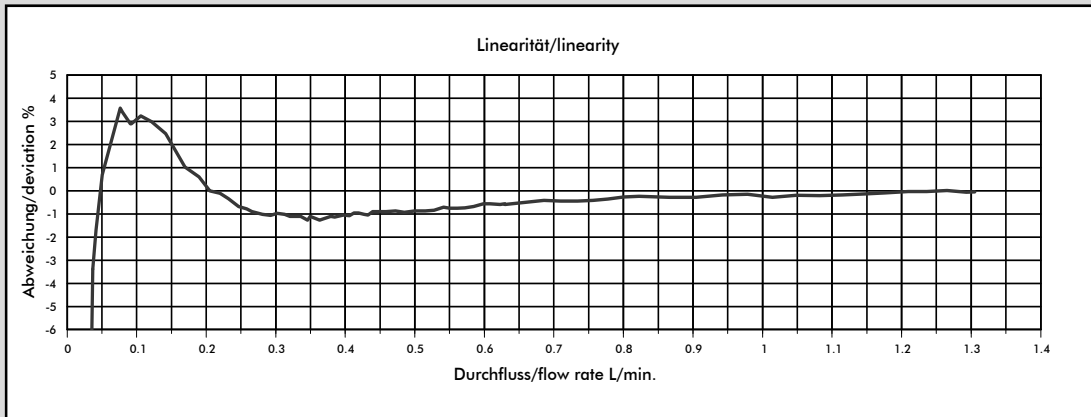

Getestet mit Wasser, max. Druck: 3.3 bar / Tested with water, max. pressure 3.3 bar

Nozzle size	Pulses/litre	g/pulse	min. flow rate in [litres/min] at linear start	max. flow rate in [litres/min]	Pressure loss in [bar]
Ø 1.00 mm	2063	0.48	0.041	0.56	1.0
Ø 1.20 mm	1700	0.59	0.050	0.82	1.0
Ø 2.00 mm	988	1.00	0.091	2.40	1.0
Ø 2.50 mm	760	1.31	0.150	3.74	1.0
Ø 3.00 mm	565	1.76	0.102	5.63	1.0
Ø 4.00 mm	381	2.62	0.123	8.38	0.8
Ø 5.60 mm	236	4.22	0.308	9.26	0.5

MEASUREMENT TIPS

- Ensure that there is no fast-pulsatory movement of the media
- Ensure that there are no reverse pressure surges
- Ensure that there is no air in the system
- Keep the pressure loss as small as possible
- Note the mounting position of the flowmeter
- Min/max flow should be in the linear range of the selected flowmeter
- Clean the system at appropriate intervals
- Avoid electrical current peaks
- Incorrect cabling of power supply +, signal and ground will destroy the flowmeter
- Do not mechanically load electrical contacts
- Avoid moisture on the electrical contacts
- Avoid stray pick-up via the cable (Do not lay cables in parallel with high current loads)

The values specified must be considered as approximate values.

The number of pulses per litre may differ depending on medium and installation.

We recommend to calibrate the number of pulses per litre in line with the complete installation.

Measurement Curve FHKU Ø2.00mm (#938-2520/FTL02)

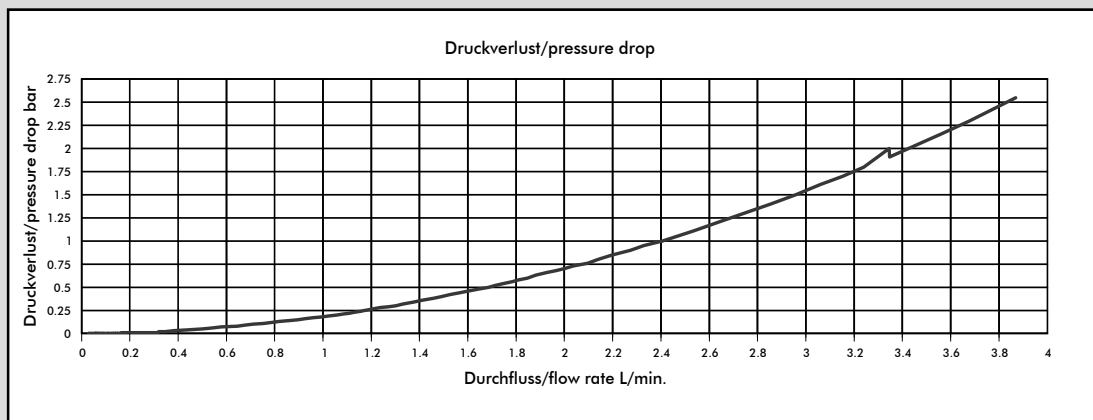
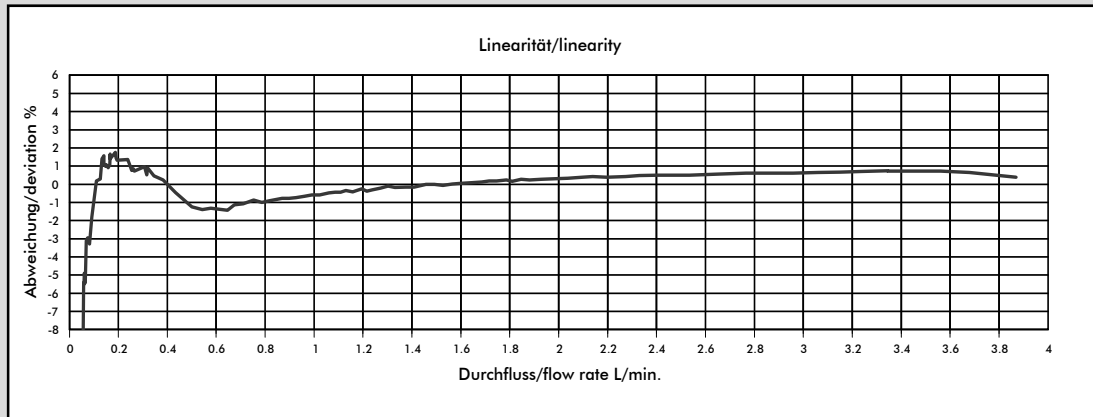

Getestet mit Wasser, max. Druck: 3.3 bar / Tested with water, max. pressure 3.3

Nozzle size	Pulses/litre	g/pulse	min. flow rate in [litres/min] at linear start	max. flow rate in [litres/min]	Pressure loss in [bar]
Ø 1.00 mm	2063	0.48	0.041	0.56	1.0
Ø 1.20 mm	1700	0.59	0.050	0.82	1.0
Ø 2.00 mm	988	1.00	0.091	2.40	1.0
Ø 2.50 mm	760	1.31	0.150	3.74	1.0
Ø 3.00 mm	565	1.76	0.102	5.63	1.0
Ø 4.00 mm	381	2.62	0.123	8.38	0.8
Ø 5.60 mm	236	4.22	0.308	9.26	0.5

MEASUREMENT TIPS

- Ensure that there is no fast-pulsatory movement of the media
- Ensure that there are no reverse pressure surges
- Ensure that there is no air in the system
- Keep the pressure loss as small as possible
- Note the mounting position of the flowmeter
- Min/max flow should be in the linear range of the selected flowmeter
- Clean the system at appropriate intervals
- Avoid electrical current peaks
- Incorrect cabling of power supply +, signal and ground will destroy the flowmeter
- Do not mechanically load electrical contacts
- Avoid moisture on the electrical contacts
- Avoid stray pick-up via the cable (Do not lay cables in parallel with high current loads)

The values specified must be considered as approximate values.

The number of pulses per litre may differ depending on medium and installation.

We recommend to calibrate the number of pulses per litre in line with the complete installation.

Measurement Curve FHKU Ø2.50mm (#938-2525/FTL02)

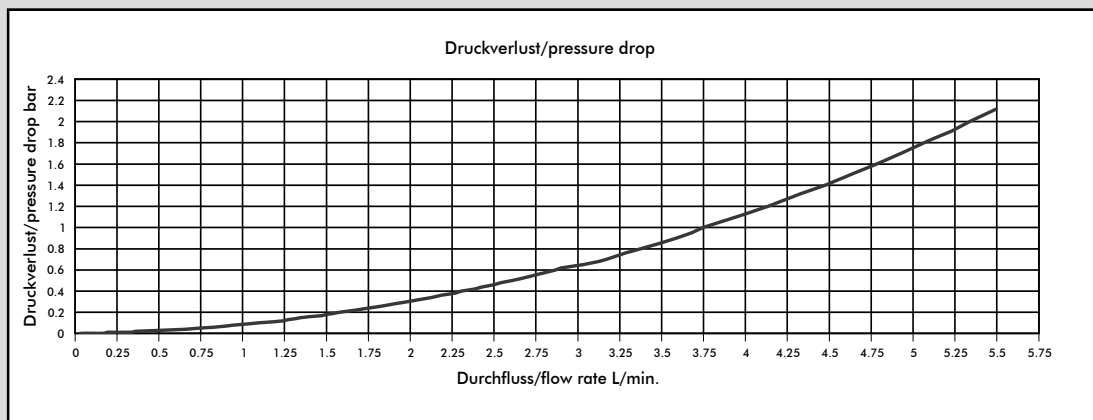
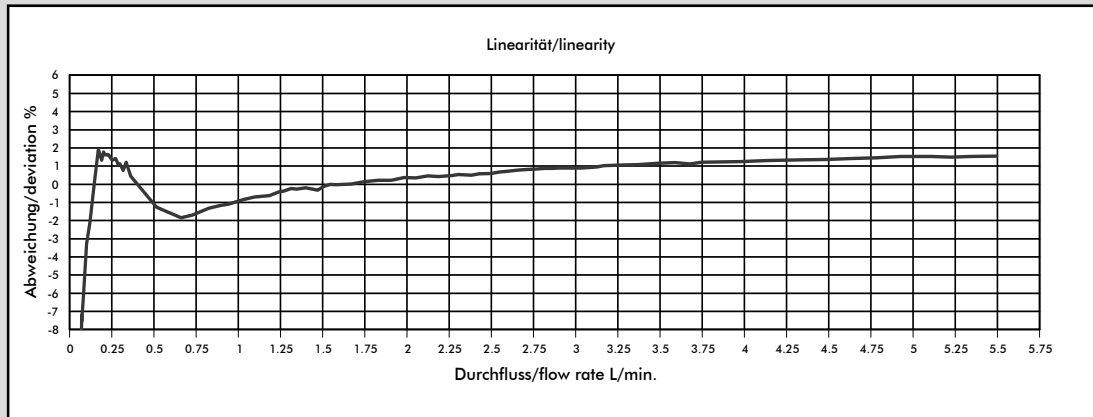

Getestet mit Wasser, max. Druck: 3.3 bar / Tested with water, max. pressure 3.3 bar

Nozzle size	Pulses/litre	g/pulse	min. flow rate in [litres/min] at linear start	max. flow rate in [litres/min]	Pressure loss in [bar]
Ø 1.00 mm	2063	0.48	0.041	0.56	1.0
Ø 1.20 mm	1700	0.59	0.050	0.82	1.0
Ø 2.00 mm	988	1.00	0.091	2.40	1.0
Ø 2.50 mm	760	1.31	0.150	3.74	1.0
Ø 3.00 mm	565	1.76	0.102	5.63	1.0
Ø 4.00 mm	381	2.62	0.123	8.38	0.8
Ø 5.60 mm	236	4.22	0.308	9.26	0.5

MEASUREMENT TIPS

- Ensure that there is no fast-pulsatory movement of the media
- Ensure that there are no reverse pressure surges
- Ensure that there is no air in the system
- Keep the pressure loss as small as possible
- Note the mounting position of the flowmeter
- Min/max flow should be in the linear range of the selected flowmeter
- Clean the system at appropriate intervals
- Avoid electrical current peaks
- Incorrect cabling of power supply +, signal and ground will destroy the flowmeter
- Do not mechanically load electrical contacts
- Avoid moisture on the electrical contacts
- Avoid stray pick-up via the cable (Do not lay cables in parallel with high current loads)

The values specified must be considered as approximate values.

The number of pulses per litre may differ depending on medium and installation.

We recommend to calibrate the number of pulses per litre in line with the complete installation.

Measurement Curve FHKU Ø3.00mm (#938-2530/TL02)

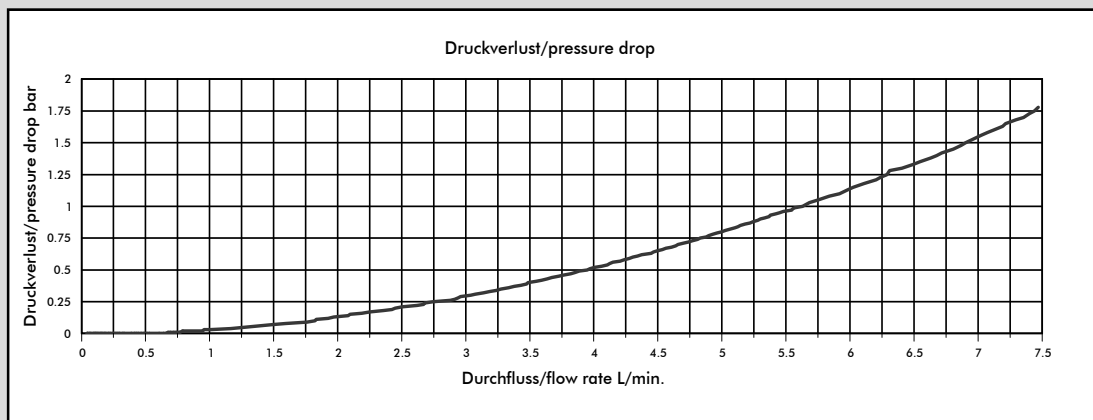
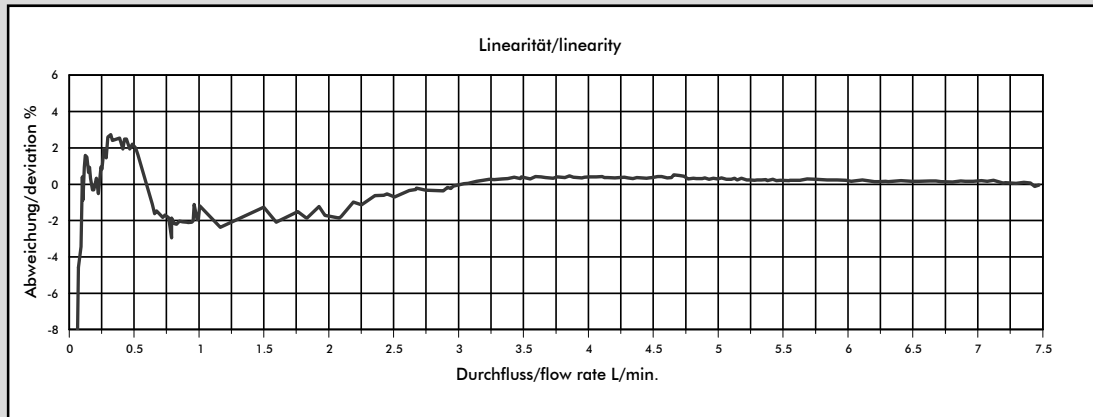

Getestet mit Wasser, max. Druck: 3.3 bar / Tested with water, max. pressure 3.3 bar

Nozzle size	Pulses/litre	g/pulse	min. flow rate in [litres/min] at linear start	max. flow rate in [litres/min]	Pressure loss in [bar]
Ø 1.00 mm	2063	0.48	0.041	0.56	1.0
Ø 1.20 mm	1700	0.59	0.050	0.82	1.0
Ø 2.00 mm	988	1.00	0.091	2.40	1.0
Ø 2.50 mm	760	1.31	0.150	3.74	1.0
Ø 3.00 mm	565	1.76	0.102	5.63	1.0
Ø 4.00 mm	381	2.62	0.123	8.38	0.8
Ø 5.60 mm	236	4.22	0.308	9.26	0.5

MEASUREMENT TIPS

- Ensure that there is no fast-pulsatory movement of the media
- Ensure that there are no reverse pressure surges
- Ensure that there is no air in the system
- Keep the pressure loss as small as possible
- Note the mounting position of the flowmeter
- Min/max flow should be in the linear range of the selected flowmeter
- Clean the system at appropriate intervals
- Avoid electrical current peaks
- Incorrect cabling of power supply +, signal and ground will destroy the flowmeter
- Do not mechanically load electrical contacts
- Avoid moisture on the electrical contacts
- Avoid stray pick-up via the cable (Do not lay cables in parallel with high current loads)

The values specified must be considered as approximate values.

The number of pulses per litre may differ depending on medium and installation.

We recommend to calibrate the number of pulses per litre in line with the complete installation.

Measurement Curve FHKU Ø4.00mm (#938-2540/TL02)

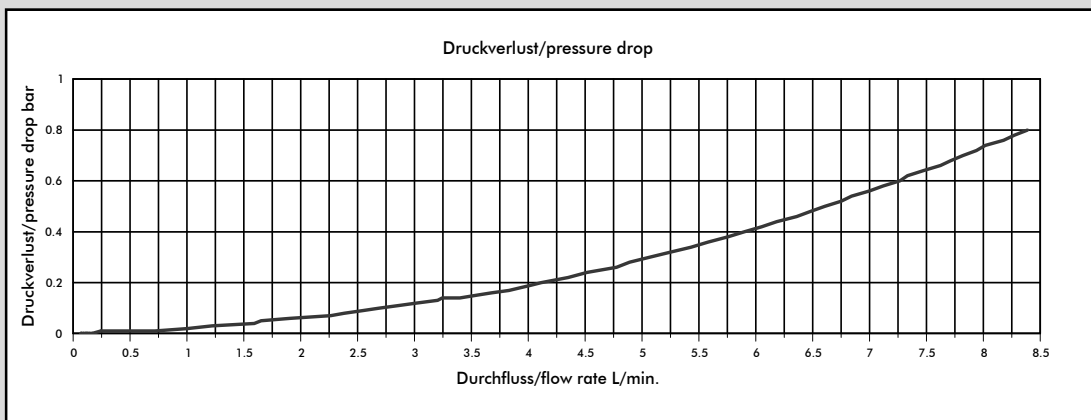
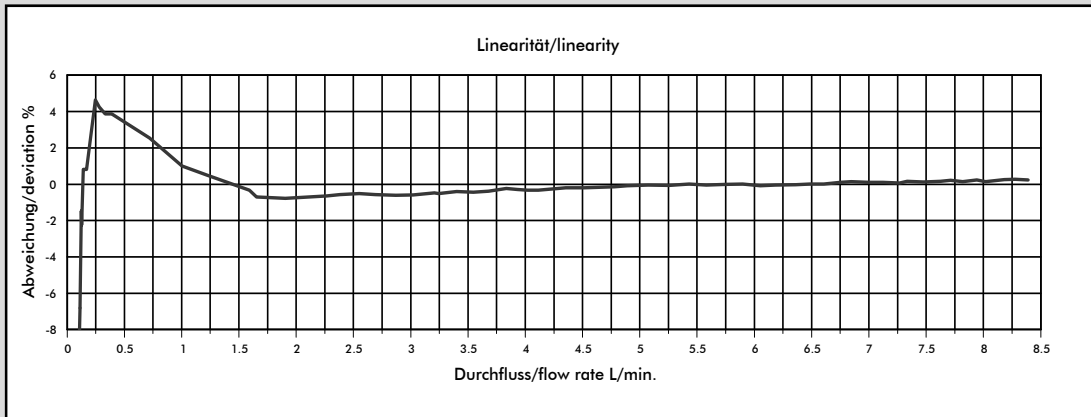

Getestet mit Wasser, max. Druck: 3.3 bar / Tested with water, max. pressure 3.3 bar

Nozzle size	Pulses/litre	g/pulse	min. flow rate in [litres/min] at linear start	max. flow rate in [litres/min]	Pressure loss in [bar]
Ø 1.00 mm	2063	0.48	0.041	0.56	1.0
Ø 1.20 mm	1700	0.59	0.050	0.82	1.0
Ø 2.00 mm	988	1.00	0.091	2.40	1.0
Ø 2.50 mm	760	1.31	0.150	3.74	1.0
Ø 3.00 mm	565	1.76	0.102	5.63	1.0
Ø 4.00 mm	381	2.62	0.123	8.38	0.8
Ø 5.60 mm	236	4.22	0.308	9.26	0.5

MEASUREMENT TIPS

- Ensure that there is no fast-pulsatory movement of the media
- Ensure that there are no reverse pressure surges
- Ensure that there is no air in the system
- Keep the pressure loss as small as possible
- Note the mounting position of the flowmeter
- Min/max flow should be in the linear range of the selected flowmeter
- Clean the system at appropriate intervals
- Avoid electrical current peaks
- Incorrect cabling of power supply +, signal and ground will destroy the flowmeter
- Do not mechanically load electrical contacts
- Avoid moisture on the electrical contacts
- Avoid stray pick-up via the cable (Do not lay cables in parallel with high current loads)

The values specified must be considered as approximate values.

The number of pulses per litre may differ depending on medium and installation.

We recommend to calibrate the number of pulses per litre in line with the complete installation.

Measurement Curve FHKU Ø5.60mm (#938-2556/TL02)

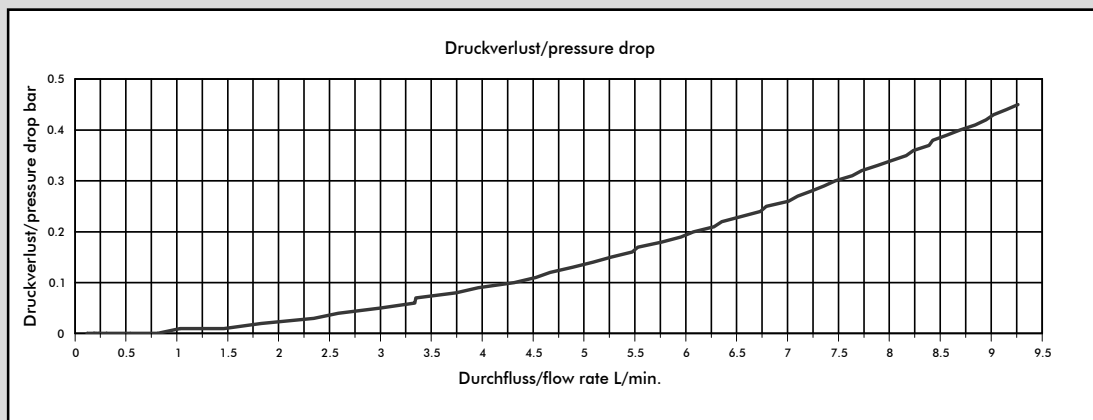
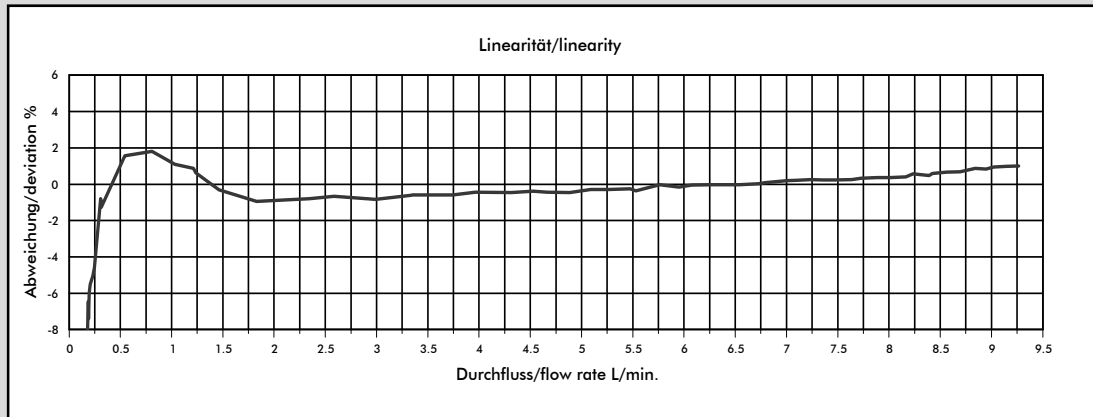

Getestet mit Wasser, max. Druck: 3.3 bar / Tested with water, max. pressure 3.3 bar

Nozzle size	Pulses/litre	g/pulse	min. flow rate in [litres/min] at linear start	max. flow rate in [litres/min]	Pressure loss in [bar]
Ø 1.00 mm	2063	0.48	0.041	0.56	1.0
Ø 1.20 mm	1700	0.59	0.050	0.82	1.0
Ø 2.00 mm	988	1.00	0.091	2.40	1.0
Ø 2.50 mm	760	1.31	0.150	3.74	1.0
Ø 3.00 mm	565	1.76	0.102	5.63	1.0
Ø 4.00 mm	381	2.62	0.123	8.38	0.8
Ø 5.60 mm	236	4.22	0.308	9.26	0.5

MEASUREMENT TIPS

- Ensure that there is no fast-pulsatory movement of the media
- Ensure that there are no reverse pressure surges
- Ensure that there is no air in the system
- Keep the pressure loss as small as possible
- Note the mounting position of the flowmeter
- Min/max flow should be in the linear range of the selected flowmeter
- Clean the system at appropriate intervals
- Avoid electrical current peaks
- Incorrect cabling of power supply +, signal and ground will destroy the flowmeter
- Do not mechanically load electrical contacts
- Avoid moisture on the electrical contacts
- Avoid stray pick-up via the cable (Do not lay cables in parallel with high current loads)

The values specified must be considered as approximate values.

The number of pulses per litre may differ depending on medium and installation.

We recommend to calibrate the number of pulses per litre in line with the complete installation.