

DATA SHEET

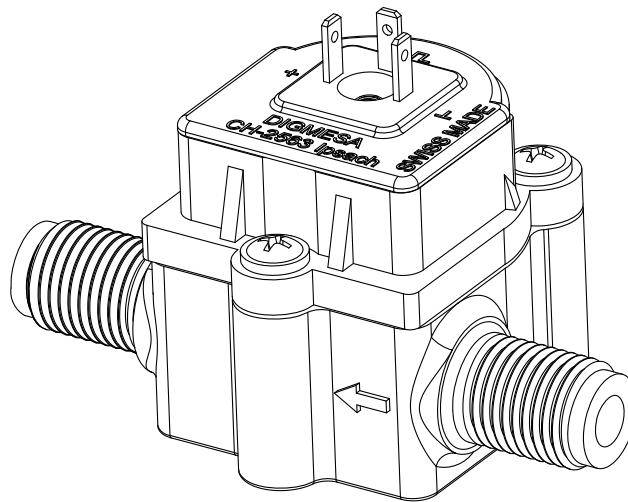

DIGMESA⁺
CHOOSE THE ORIGINAL

FHKU G1/4" PVDF
Part number: 938-13xx-C01x

Digma AG, Keltenstrasse 31, CH-2563 Ipsach / Switzerland
Phone +41 (32) 332 77 77, Fax +41 (32) 332 77 88

www.digma.com

Version 06 FHKU G1/4" PVDF 938-13xx-C01x GB Page 1-10

General Description

The FHKU Flowmeter is a general-purpose device; its working range can be individually defined according to its nozzle size. It is employed for measuring, regulating or metering and guarantees most precise measurement of fluid quantities. In addition, a pulse generator integrated into the flowmeter guarantees a practically unlimited useful life.

Special features: Able to withstand high temperatures, good resistance to chemicals. Linear inlet and outlet, compact design, great working range, depending on the nozzle diameter. **Employed in the semiconductor (wafer polishing) sector due to the high purity of materials used.**

Approvals / Standards

EN55014-1:00+A1:01+A2:02, EN61000-6-3:01+A11:04, IEC61000-6-3:06(ed.2.0), EN61000-3-2:06, IEC61000-3-2:05(ed.3.0), EN61000-3-3:95+A1:01+A2:05, IEC61000-3-3:94+A1:01+A2:05(Cons.ed 1.2), EN55014-2:97+A1:01, EN61000-6-1:01, IEC61000-6-1:05(ed.2)



Material:

Housing:	PVDF
Bearing pin:	PCTFE
Nozzle:	Ø 1.0, 1.2, 2.0, 2.5, 3.0, 4.0mm PTFE
Nozzle:	Ø 5.6mm PVDF
O-ring:	FPM (Viton) EPDM / Kalrez on request
Turbine:	PVDF
Magnets:	2 or 4 magnets (not in contact with the medium)
Screws:	Inox A2 PT-screws (Phillips cross recessed)

Technical data:

Flow rate:	0.04 - 15 l/min depending on the nozzle diameter
Continuous operation:	< 500 rpm of the turbine
Measuring accuracy:	+/- 2.0% *
Repetition:	< +/- 0.25%
Temperature range:	-10°C to +100°C 14°F to 212°F
Pressure range:	20 bar at 20°C 290 psi/68°F
Mounting position:	Horizontal *
Nozzle size:	Ø 1.0, 1.2, 2.0, 2.5, 3.0, 4.0, 5.6mm

Electrical connection ratings:

Power supply:	+3.8 to +24 VDC
Consumption:	< 8 mA
Signal connection:	Open collector NPN
Signal voltage:	0 VDC GND (saturation < 0.7 V)
Signal load:	max. 20 mA
Leakage current:	max. 10 µA
Connections:	3Pin- AMP 2.8 x 0.8 mm
Signal:	Square-wave output
Duty Cycle:	~ 50%

* Accuracy in the linear range for individually calibrated equipment

Dimensions in mm:

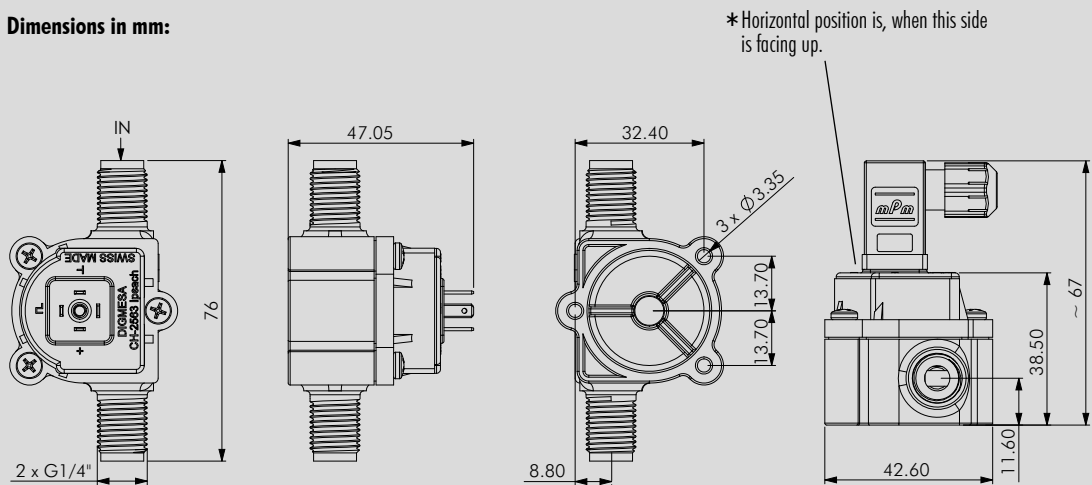

Options: 3-pin valve connector
Item number: 941-0010-3



We reserve the right to make modifications in the interests of technical progress.

RESISTANCE

Special regulations which must be complied with by the flowmeter manufacturer apply to each country, e.g. CE, NSF, FDA and SK. The various media flowing through the flowmeter differ from application to application. You are advised to enquire with the medium manufacturer as to whether the entire installation and the flowmeter are resistant to the medium itself (see Material)!

ELECTRONIC

DIGMESA electronic circuitry is always designed for operation with DIGMESA flowmeters. Please note the following if connecting to other electronic circuitry:

- The flowmeter does not supply an output voltage but switches the signal terminal to 0 V ground (actuated) or leaves it open (non-actuated)
- There must be a pull-up resistor between power supply + and signal depending on electronic circuitry!

Version 06 FHKU G1/4" PVDF 938-13xx-C01x GB Page 2-10

Interface Connection: Examples Open Collector

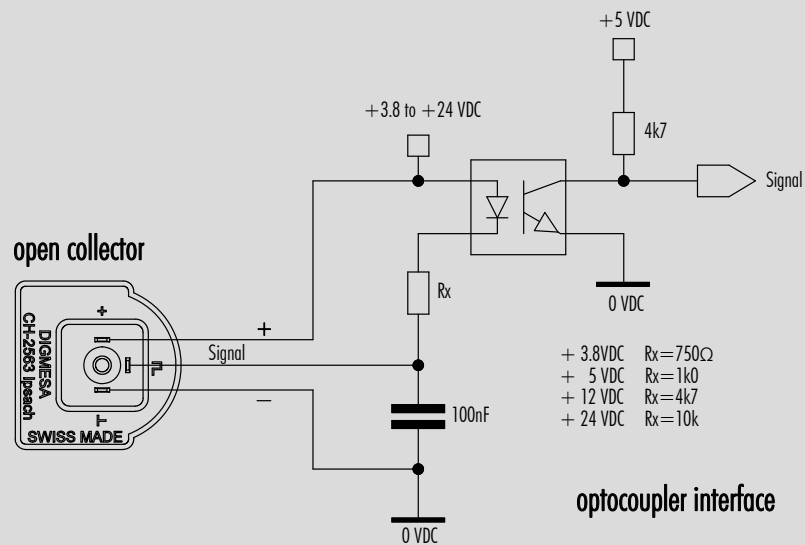
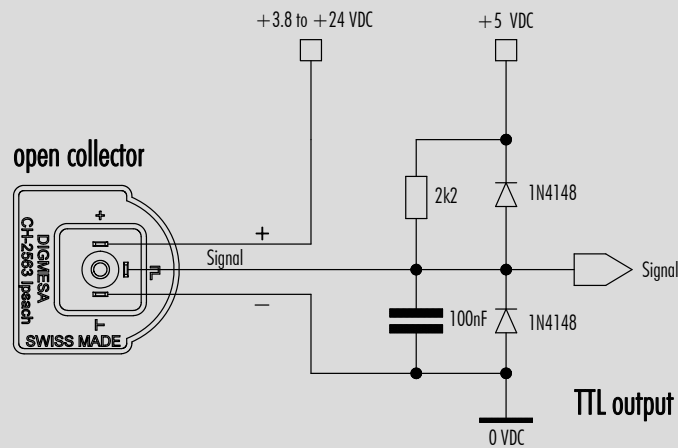
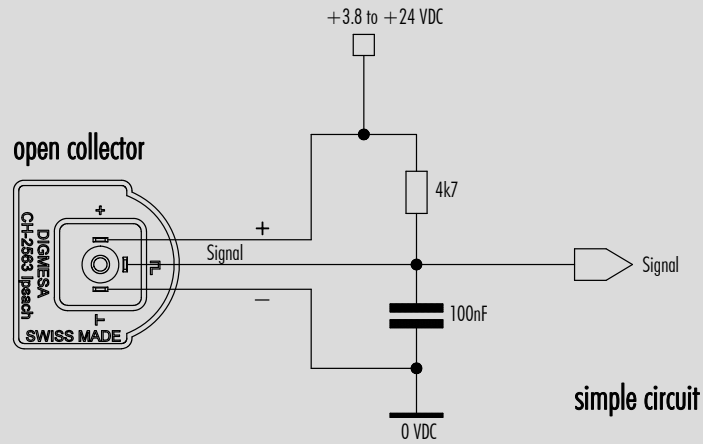

Measurement Curve FHKU Ø1.00mm

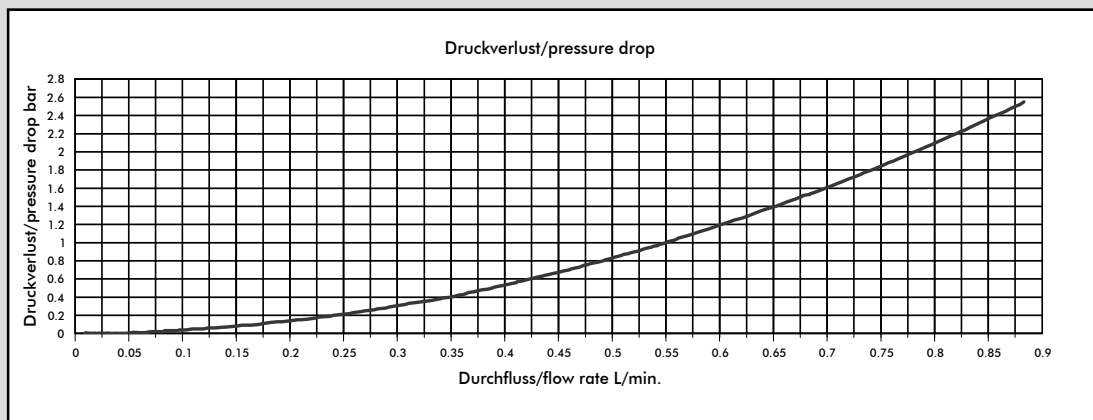
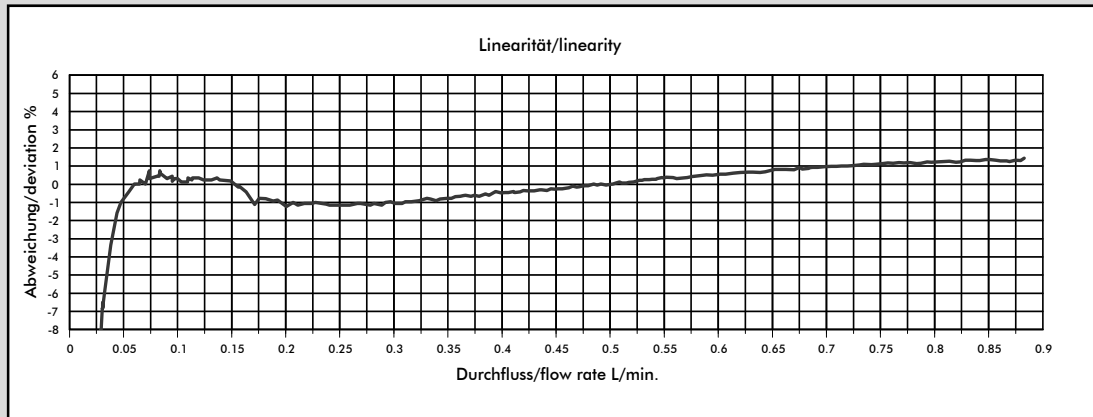

Getestet mit Wasser, max. Druck: 3.3 bar / Tested with water, max. pressure 3.3 bar

#938-1310-C012 (2 Magnets)

Nozzle size	Pulses/litre	g/pulse	min. flow rate in [litres/min] at linear start	max. flow rate in [litres/min]	Pressure loss in [bar]
Ø 1.00 mm	2063	0.48	0.04	0.54	1.0

#938-1310-C014 (4 Magnets)

Nozzle size	Pulses/litre	g/pulse	min. flow rate in [litres/min] at linear start	max. flow rate in [litres/min]	Pressure loss in [bar]
Ø 1.00 mm	4126	0.24	0.04	0.54	1.0

The values specified must be considered as approximate values.

The number of pulses per litre may differ depending on medium and installation.

We recommend to calibrate the number of pulses per litre in line with the complete installation.

MEASUREMENT TIPS

- Ensure that there is no fast-pulsatory movement of the media
- Ensure that there are no reverse pressure surges
- Ensure that there is no air in the system
- Keep the pressure loss as small as possible
- Note the mounting position of the flowmeter
- Min/max flow should be in the linear range of the selected flowmeter
- Clean the system at appropriate intervals
- Avoid electrical current peaks
- Incorrect cabling of power supply +, signal and ground will destroy the flowmeter
- Do not mechanically load electrical contacts
- Avoid moisture on the electrical contacts
- Avoid stray pick-up via the cable (Do not lay cables in parallel with high current loads)

Measurement Curve FHKU Ø1.20mm

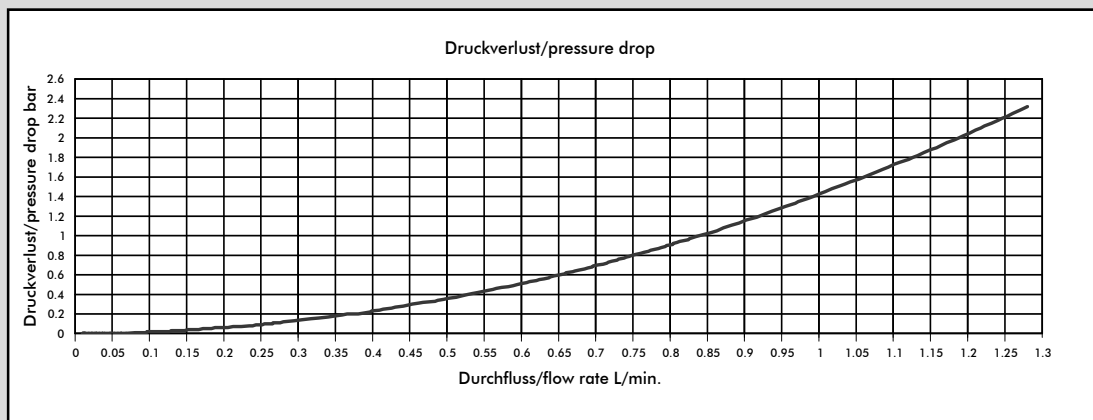
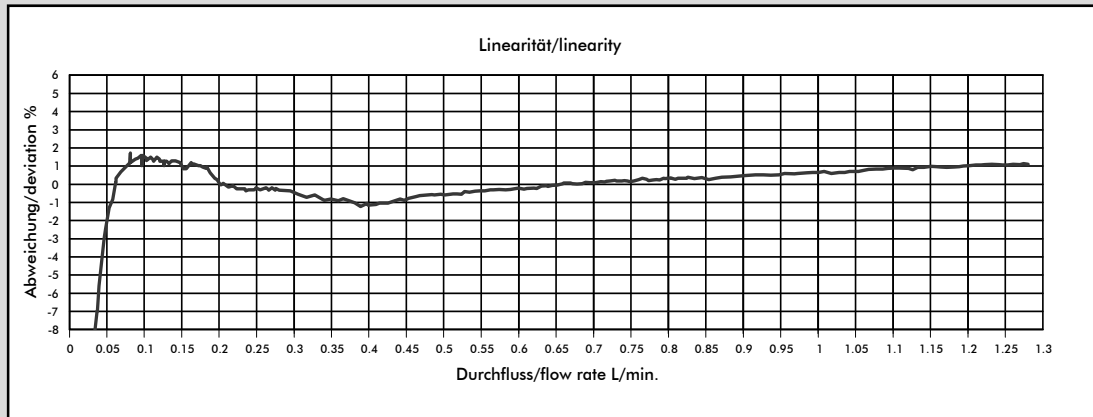

Getestet mit Wasser, max. Druck: 3.3 bar / Tested with water, max. pressure 3.3 bar

#938-1312-C012 (2 Magnets)

Nozzle size	Pulses/litre	g/pulse	min. flow rate in [litres/min] at linear start	max. flow rate in [litres/min]	Pressure loss in [bar]
Ø 1.20 mm	1700	0.59	0.05	0.84	1.0

#938-1312-C014 (4 Magnets)

Nozzle size	Pulses/litre	g/pulse	min. flow rate in [litres/min] at linear start	max. flow rate in [litres/min]	Pressure loss in [bar]
Ø 1.20 mm	3400	0.29	0.05	0.84	1.0

The values specified must be considered as approximate values.

The number of pulses per litre may differ depending on medium and installation.

We recommend to calibrate the number of pulses per litre in line with the complete installation.

MEASUREMENT TIPS

- Ensure that there is no fast-pulsatory movement of the media
- Ensure that there are no reverse pressure surges
- Ensure that there is no air in the system
- Keep the pressure loss as small as possible
- Note the mounting position of the flowmeter
- Min/max flow should be in the linear range of the selected flowmeter
- Clean the system at appropriate intervals
- Avoid electrical current peaks
- Incorrect cabling of power supply +, signal and ground will destroy the flowmeter
- Do not mechanically load electrical contacts
- Avoid moisture on the electrical contacts
- Avoid stray pick-up via the cable (Do not lay cables in parallel with high current loads)

Measurement Curve FHKU Ø2.00mm

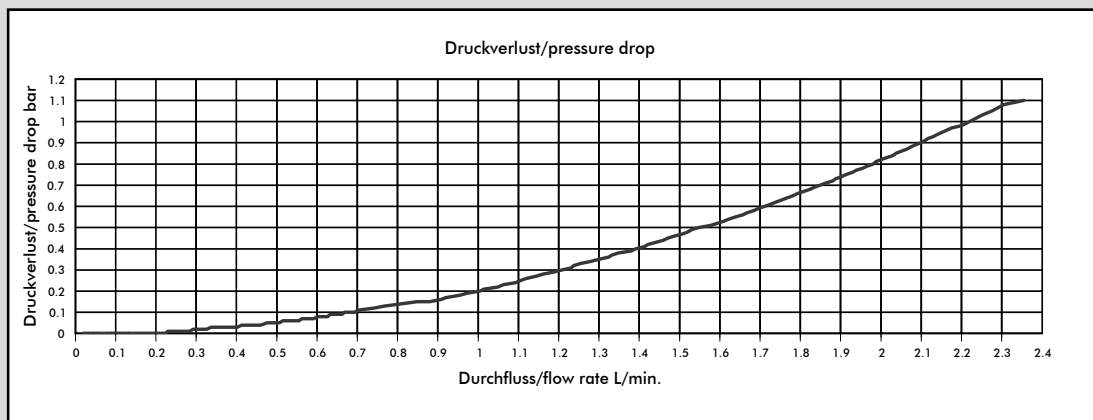
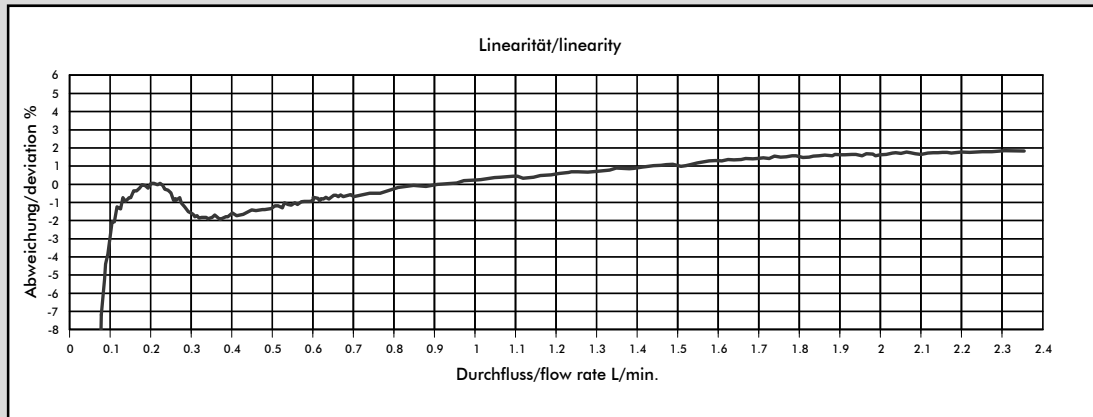

Getestet mit Wasser, max. Druck: 3.3 bar / Tested with water, max. pressure 3.3 bar

#938-1320-C012 (2 Magnets)

Nozzle size	Pulses/litre	g/pulse	min. flow rate in [litres/min] at linear start	max. flow rate in [litres/min]	Pressure loss in [bar]
Ø 2.0 mm	988	1.0	0.09	2.4	1.0

#938-1320-C014 (4 Magnets)

Nozzle size	Pulses/litre	g/pulse	min. flow rate in [litres/min] at linear start	max. flow rate in [litres/min]	Pressure loss in [bar]
Ø 2.0 mm	1976	0.5	0.09	2.4	1.0

The values specified must be considered as approximate values.

The number of pulses per litre may differ depending on medium and installation.

We recommend to calibrate the number of pulses per litre in line with the complete installation.

MEASUREMENT TIPS

- Ensure that there is no fast-pulsatory movement of the media
- Ensure that there are no reverse pressure surges
- Ensure that there is no air in the system
- Keep the pressure loss as small as possible
- Note the mounting position of the flowmeter
- Min/max flow should be in the linear range of the selected flowmeter
- Clean the system at appropriate intervals
- Avoid electrical current peaks
- Incorrect cabling of power supply +, signal and ground will destroy the flowmeter
- Do not mechanically load electrical contacts
- Avoid moisture on the electrical contacts
- Avoid stray pick-up via the cable (Do not lay cables in parallel with high current loads)

Measurement Curve FHKU Ø2.50mm

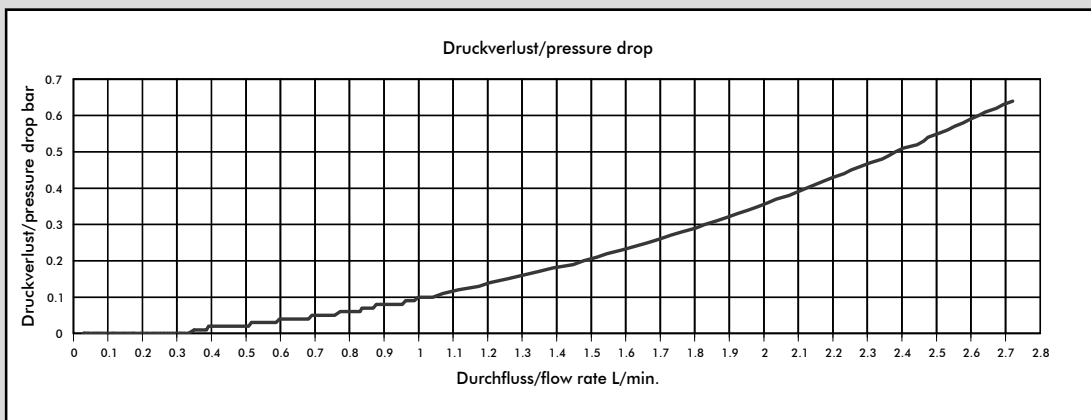
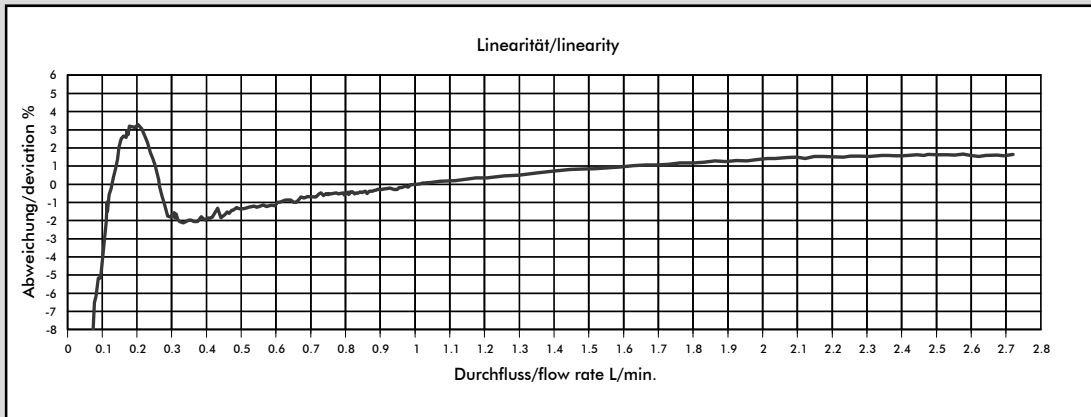

Getestet mit Wasser, max. Druck: 3.3 bar / Tested with water, max. pressure 3.3 bar

#938-1325-C012 (2 Magnets)

Nozzle size	Pulses/litre	g/pulse	min. flow rate in [litres/min] at linear start	max. flow rate in [litres/min]	Pressure loss in [bar]
Ø 2.5 mm	760	1.3	0.11	2.72	0.64

#938-1325-C014 (4 Magnets)

Nozzle size	Pulses/litre	g/pulse	min. flow rate in [litres/min] at linear start	max. flow rate in [litres/min]	Pressure loss in [bar]
Ø 2.5 mm	1520	0.65	0.11	2.72	0.64

The values specified must be considered as approximate values.

The number of pulses per litre may differ depending on medium and installation.

We recommend to calibrate the number of pulses per litre in line with the complete installation.

MEASUREMENT TIPS

- Ensure that there is no fast-pulsatory movement of the media
- Ensure that there are no reverse pressure surges
- Ensure that there is no air in the system
- Keep the pressure loss as small as possible
- Note the mounting position of the flowmeter
- Min/max flow should be in the linear range of the selected flowmeter
- Clean the system at appropriate intervals
- Avoid electrical current peaks
- Incorrect cabling of power supply +, signal and ground will destroy the flowmeter
- Do not mechanically load electrical contacts
- Avoid moisture on the electrical contacts
- Avoid stray pick-up via the cable (Do not lay cables in parallel with high current loads)

Measurement Curve FHKU Ø3.00mm

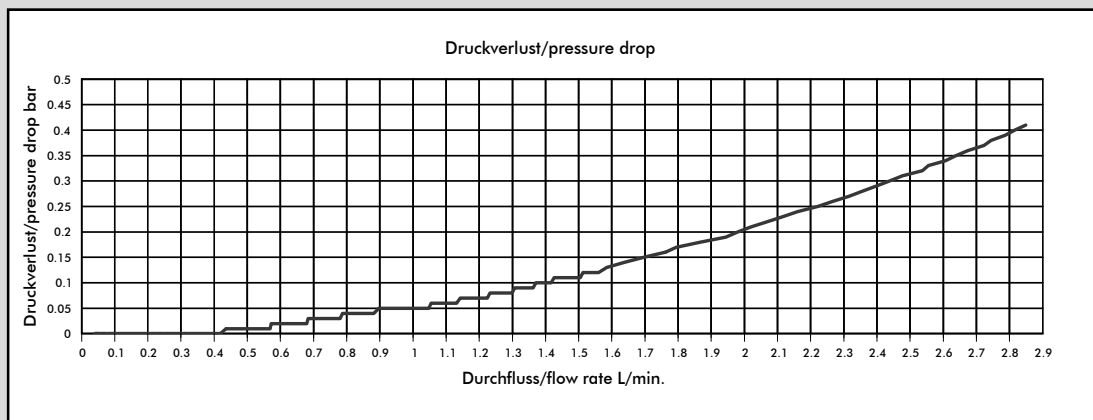
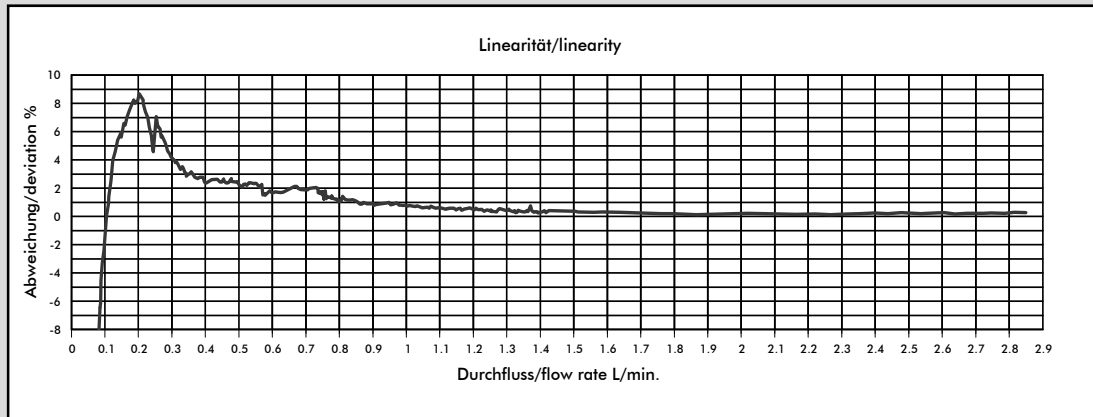

Getestet mit Wasser, max. Druck: 3.3 bar / Tested with water, max. pressure 3.3 bar

#938-1330-C012 (2 Magnets)

Nozzle size	Pulses/litre	g/pulse	min. flow rate in [litres/min] at linear start	max. flow rate in [litres/min]	Pressure loss in [bar]
Ø 3.0 mm	565	1.76	0.10	5.63	1.0

#938-1330-C014 (4 Magnets)

Nozzle size	Pulses/litre	g/pulse	min. flow rate in [litres/min] at linear start	max. flow rate in [litres/min]	Pressure loss in [bar]
Ø 3.0 mm	1130	0.88	0.10	5.63	1.0

The values specified must be considered as approximate values.

The number of pulses per litre may differ depending on medium and installation.

We recommend to calibrate the number of pulses per litre in line with the complete installation.

MEASUREMENT TIPS

- Ensure that there is no fast-pulsatory movement of the media
- Ensure that there are no reverse pressure surges
- Ensure that there is no air in the system
- Keep the pressure loss as small as possible
- Note the mounting position of the flowmeter
- Min/max flow should be in the linear range of the selected flowmeter
- Clean the system at appropriate intervals
- Avoid electrical current peaks
- Incorrect cabling of power supply +, signal and ground will destroy the flowmeter
- Do not mechanically load electrical contacts
- Avoid moisture on the electrical contacts
- Avoid stray pick-up via the cable (Do not lay cables in parallel with high current loads)

Measurement Curve FHKU Ø4.00mm

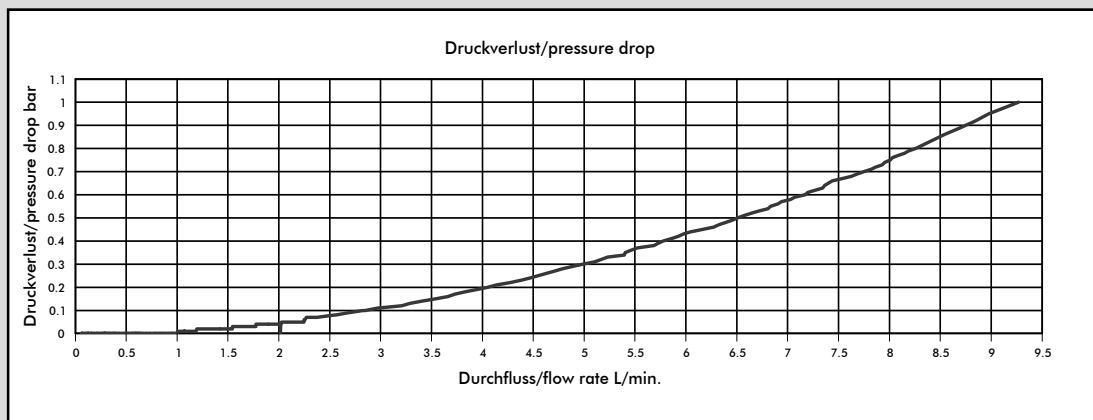
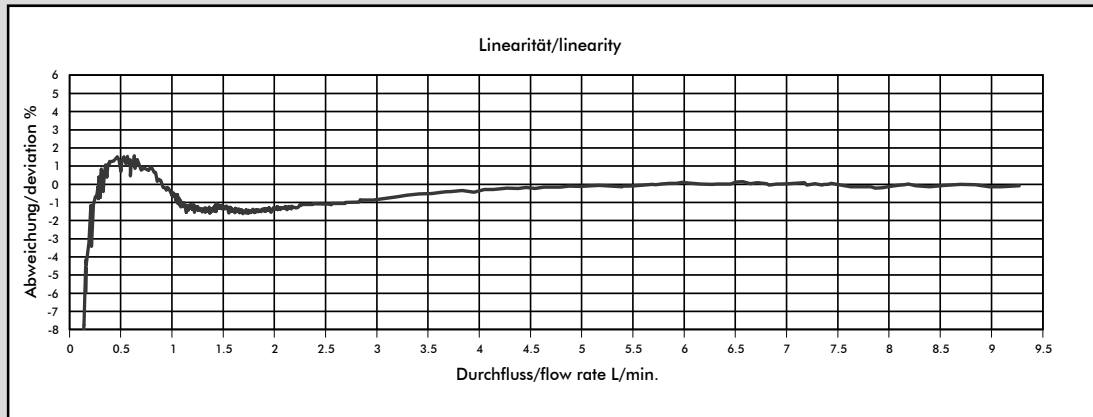

Getestet mit Wasser, max. Druck: 3.3 bar / Tested with water, max. pressure 3.3 bar

#938-1340-C012 (2 Magnets)

Nozzle size	Pulses/litre	g/pulse	min. flow rate in [litres/min] at linear start	max. flow rate in [litres/min]	Pressure loss in [bar]
Ø 4.0 mm	381	2.62	0.20	9.27	1.0

#938-1340-C014 (4 Magnets)

Nozzle size	Pulses/litre	g/pulse	min. flow rate in [litres/min] at linear start	max. flow rate in [litres/min]	Pressure loss in [bar]
Ø 4.0 mm	762	1.31	0.20	9.27	1.0

The values specified must be considered as approximate values.

The number of pulses per litre may differ depending on medium and installation.

We recommend to calibrate the number of pulses per litre in line with the complete installation.

MEASUREMENT TIPS

- Ensure that there is no fast-pulsatory movement of the media
- Ensure that there are no reverse pressure surges
- Ensure that there is no air in the system
- Keep the pressure loss as small as possible
- Note the mounting position of the flowmeter
- Min/max flow should be in the linear range of the selected flowmeter
- Clean the system at appropriate intervals
- Avoid electrical current peaks
- Incorrect cabling of power supply +, signal and ground will destroy the flowmeter
- Do not mechanically load electrical contacts
- Avoid moisture on the electrical contacts
- Avoid stray pick-up via the cable (Do not lay cables in parallel with high current loads)

Measurement Curve FHKU Ø5.60mm

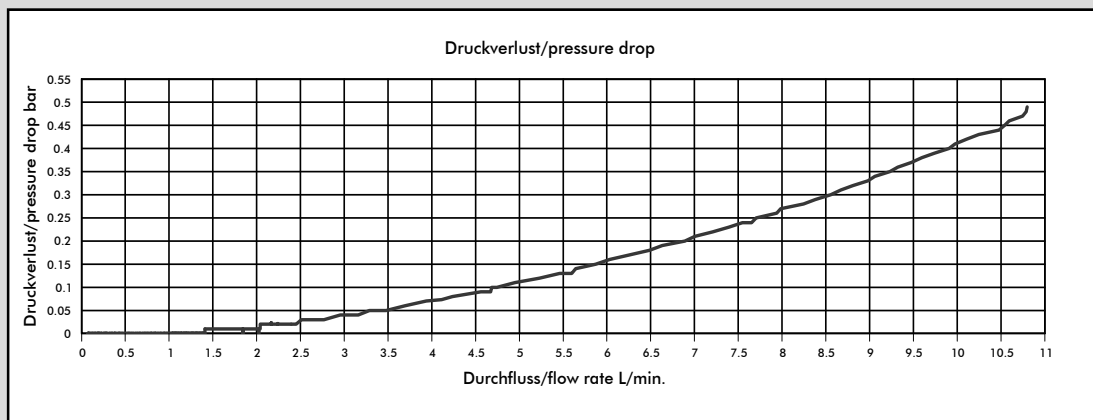
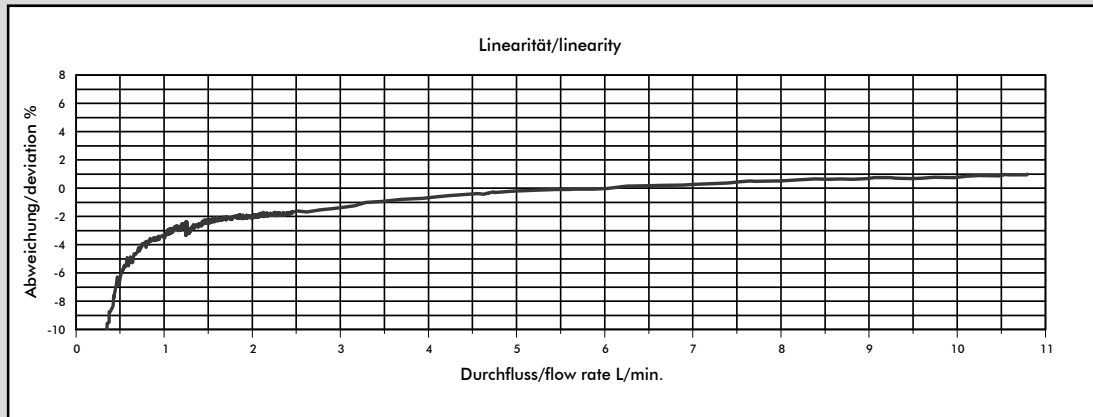

Getestet mit Wasser, max. Druck: 3.3 bar / Tested with water, max. pressure 3.3 bar

#938-1356-C012 (2 Magnets)

Nozzle size	Pulses/litre	g/pulse	min. flow rate in [litres/min] at linear start	max. flow rate in [litres/min]	Pressure loss in [bar]
Ø 5.6 mm	236	4.22	1.78	10.79	0.5

#938-1356-C014 (4 Magnets)

Nozzle size	Pulses/litre	g/pulse	min. flow rate in [litres/min] at linear start	max. flow rate in [litres/min]	Pressure loss in [bar]
Ø 5.6 mm	472	2.11	1.78	10.79	0.5

The values specified must be considered as approximate values.

The number of pulses per litre may differ depending on medium and installation.

We recommend to calibrate the number of pulses per litre in line with the complete installation.

MEASUREMENT TIPS

- Ensure that there is no fast-pulsatory movement of the media
- Ensure that there are no reverse pressure surges
- Ensure that there is no air in the system
- Keep the pressure loss as small as possible
- Note the mounting position of the flowmeter
- Min/max flow should be in the linear range of the selected flowmeter
- Clean the system at appropriate intervals
- Avoid electrical current peaks
- Incorrect cabling of power supply +, signal and ground will destroy the flowmeter
- Do not mechanically load electrical contacts
- Avoid moisture on the electrical contacts
- Avoid stray pick-up via the cable (Do not lay cables in parallel with high current loads)