

# DATA SHEET

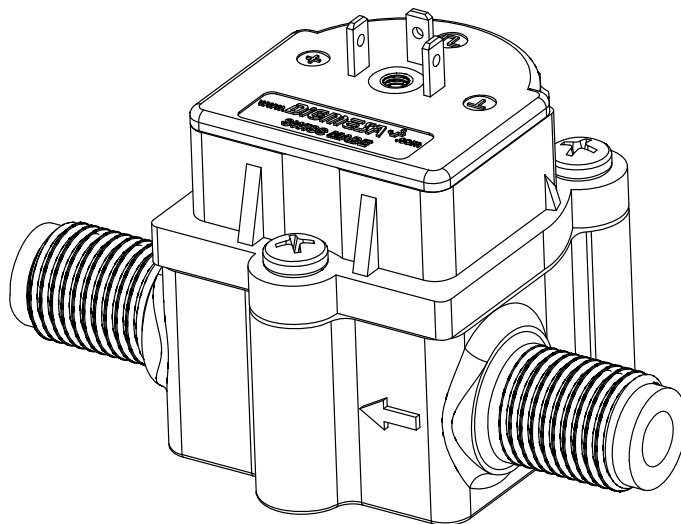

**DIGMESA**<sup>+</sup>  
CHOOSE THE ORIGINAL

---

**FHKU G1/4" High Flow**  
Part number: 938-12xx-xK34x

Digma AG, Keltenstrasse 31, CH-2563 Ipsach / Switzerland  
Phone +41 (32) 332 77 77, Fax +41 (32) 332 77 88

[www.digma.com](http://www.digma.com)

Version 04 FHKU G1/4" High Flow #938-12xx-xK34x GB Page 1-10

# General Description

The FHKU Flowmeter is a general-purpose device; its working range can be individually defined according to its nozzle size. It is employed for measuring, regulating or metering and guarantees most precise measurement of fluid quantities. In addition, a pulse generator integrated into the flowmeter guarantees a practically unlimited useful life.

**Specific applications:** Linear inlet and outlet, compact design, great working range, depending on the nozzle diameter. High precision, robust storage, suitably for continuous operation.

## Approvals / Standards

EN55014-1:00+A1:01+A2:02, EN61000-6-3:01+A11:04, IEC61000-6-3:06(ed.2.0), EN61000-3-2:06, IEC61000-3-2:05(ed.3.0), EN61000-3-3:95+A1:01+A2:05, IEC61000-3-3:94+A1:01+A2:05(Cons.ed 1.2), EN55014-2:97+A1:01, EN61000-6-1:01, IEC61000-6-1:05(ed.2)



## Material:

Housing:	PPS 40%GF
Bearing pin:	Ceramic
Nozzle:	Ø 1.0, 1.2, 2.0, 2.5, 3.0, 4.0, 5.6 mm PPS 40%GF
O-ring:	MVQ (Silikon) FPM (Viton) / EPDM on request
Turbine:	PVDF
Magnets:	2 or 4 magnets (not in contact with the medium)
Screws:	PT-screws Inox A2 (Phillips cross recessed)

## Technical data:

Flow rate:	from 0.041 l/min
Speed:	max. 1900 rpm of the turbine
Measuring accuracy:	+/- 2.0% *
Repetition:	< +/- 0.25%
Temperature range:	-10°C to +100°C 14°F to 212°F
Pressure range:	20 bar at 20°C 290 psi /68°F
Mounting position:	Horizontal *
Nozzle size:	Ø 1.0, 1.2, 2.0, 2.5, 3.0, 4.0, 5.6mm

## Electrical connection ratings:

Power supply:	+3.8 to +24 VDC
Consumption:	<8 mA
Signal connection:	Open collector NPN
Signal voltage:	0 VDC GND (saturation <0.7 V)
Signal load:	max. 20 mA
Leakage current:	max. 10 µA
Connections:	3Pin- AMP 2.8 x 0.8 mm
Signal:	Square-wave output
Duty Cycle:	~50%

\* Accuracy in the linear range for individually calibrated equipment

## Dimensions in mm:

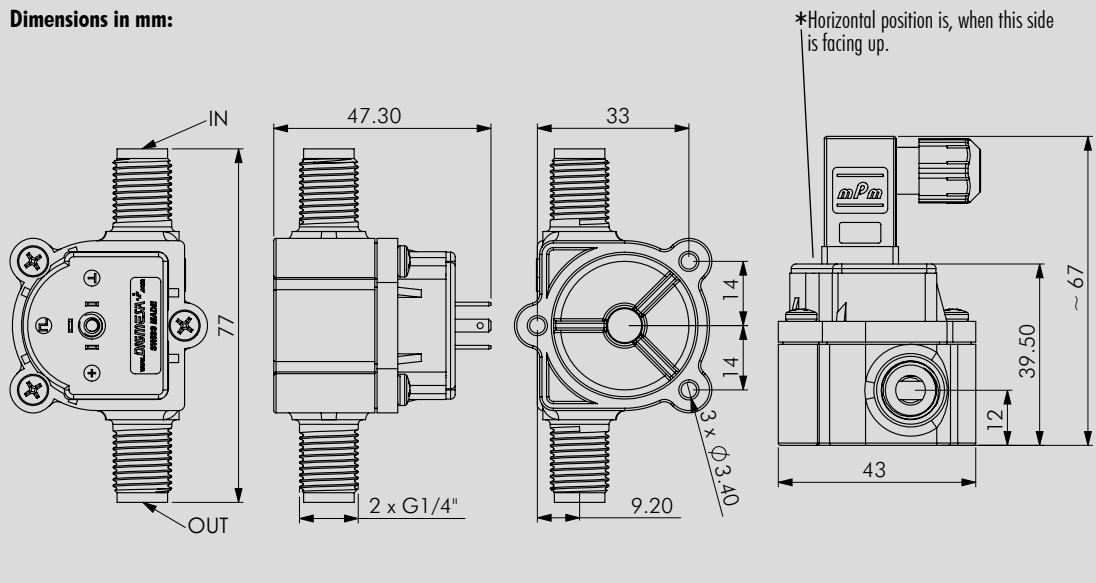

**Options:** 3-pin valve connector  
Item number: 941-0010-3

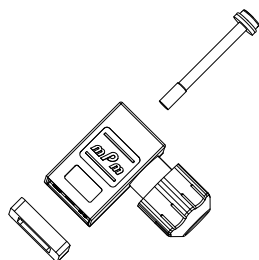

We reserve the right to make modifications in the interests of technical progress.

## RESISTANCE

Special regulations which must be complied with by the flowmeter manufacturer apply to each country, e.g. CE, NSF, FDA and SK. The various media flowing through the flowmeter differ from application to application. You are advised to enquire with the medium manufacturer as to whether the entire installation and the flowmeter are resistant to the medium itself (see Material)!

## ELECTRONIC

DIGMESA electronic circuitry is always designed for operation with DIGMESA flowmeters. Please note the following if connecting to other electronic circuitry:

- The flowmeter does not supply an output voltage but switches the signal terminal to 0 V ground (actuated) or leaves it open (non-actuated)
- There must be a pull-up resistor between power supply + and signal depending on electronic circuitry!

Version 04 FHKU G1/4" High Flow #938-12xx-xK34x GB Page 2-10

# Interface Connection: Examples Open Collector

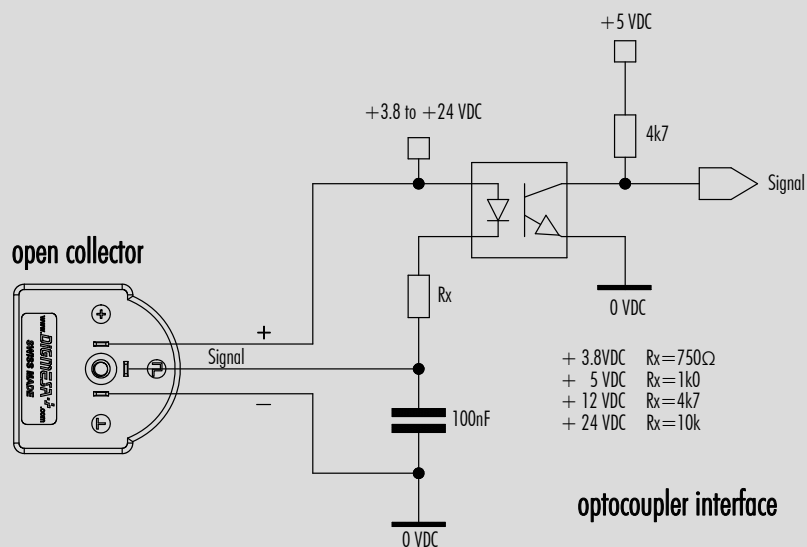
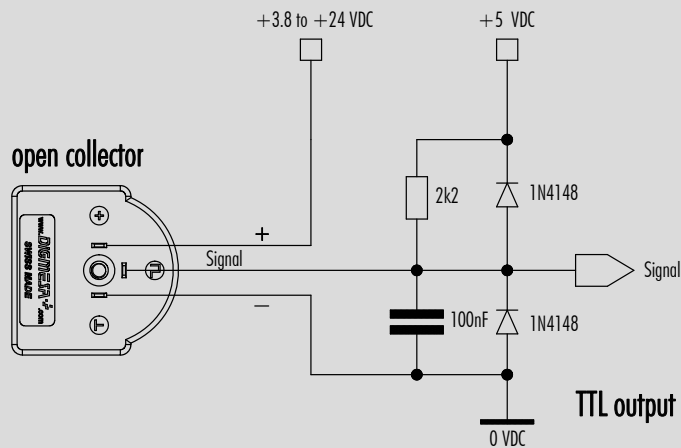
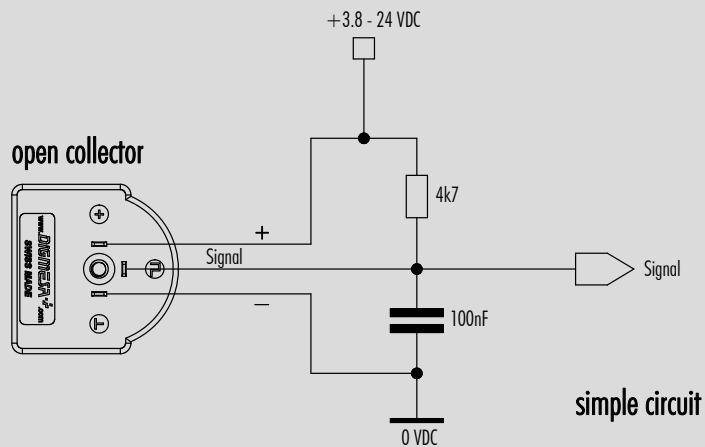

# Measurement Curve FHKU G1/4" Ø1.00mm High Flow

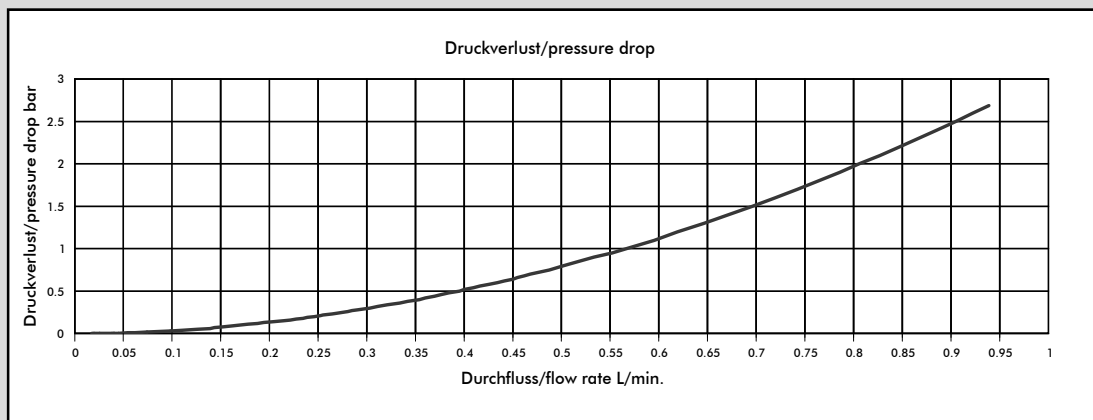
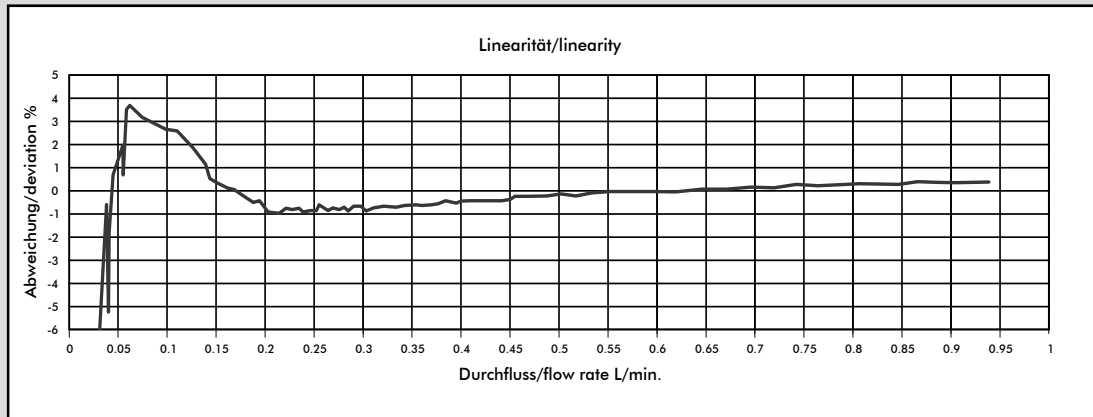

Medium: Water / max. Pressure: 3.3 bar

Number of magnets	Nozzle size	Pulses/Litres	Gramm/Puls	Recommended min. flow rate at [l/min]	Flow rate at 1900 rpm [l/min]
2	Ø 1.00 mm	2223	0.45	0.027	0.85
4	Ø 1.00 mm	4446	0.22	0.027	0.85

Part number:

Nozzle Ø 1.0mm with 2 Magnets: #938-1210-FK342

Nozzle Ø 1.0mm with 4 Magnets: #938-1210-FK344

**The values specified must be considered as approximate values.**

**The number of pulses per litre may differ depending on medium and installation.**

**We recommend to calibrate the number of pulses per litre in line with the complete installation.**

## MEASUREMENT TIPS

- Ensure that there is no fast-pulsatory movement of the media
- Ensure that there are no reverse pressure surges
- Ensure that there is no air in the system
- Keep the pressure loss as small as possible
- Note the mounting position of the flowmeter
- Min/max flow should be in the linear range of the selected flowmeter
- Clean the system at appropriate intervals
- Avoid electrical current peaks
- Incorrect cabling of power supply +, signal and ground will destroy the flowmeter
- Do not mechanically load electrical contacts
- Avoid moisture on the electrical contacts
- Avoid stray pick-up via the cable (Do not lay cables in parallel with high current loads)

# Measurement Curve FHKU G1/4" Ø1.20mm High Flow

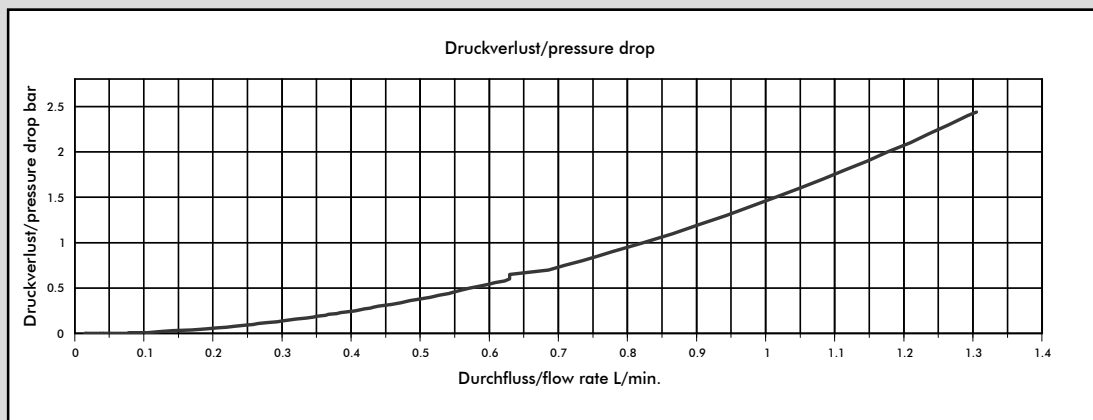
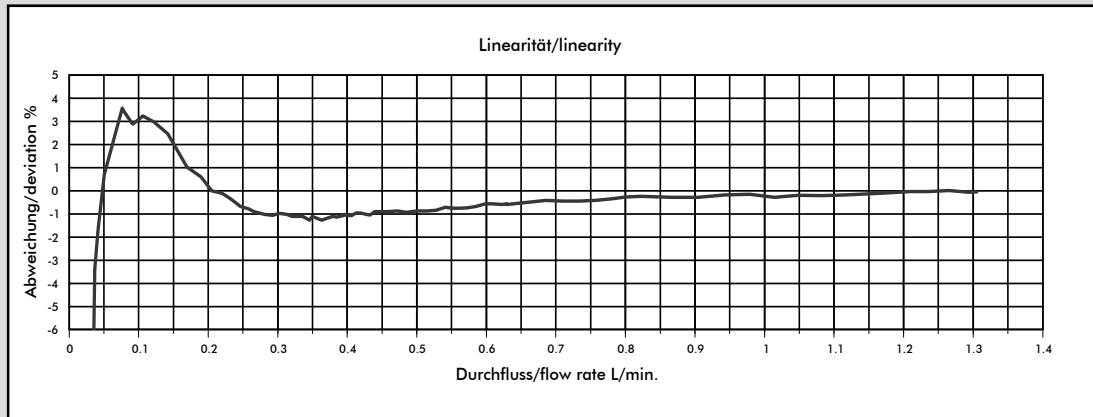

Medium: Water / max. Pressure: 3.3 bar

Number of magnets	Nozzle size	Pulses/Litres	Gramm/Puls	Recommended min. flow rate at [l/min]	Flow rate at 1900 rpm [l/min]
2	Ø 1.20 mm	1787	0.56	0.031	1.06
4	Ø 1.20 mm	3574	0.28	0.031	1.06

Part number:

Nozzle Ø 1.2mm with 2 Magnets: #938-1212-FK342

Nozzle Ø 1.2mm with 4 Magnets: #938-1212-FK344

**The values specified must be considered as approximate values.**

**The number of pulses per litre may differ depending on medium and installation.**

**We recommend to calibrate the number of pulses per litre in line with the complete installation.**

## MEASUREMENT TIPS

- Ensure that there is no fast-pulsatory movement of the media
- Ensure that there are no reverse pressure surges
- Ensure that there is no air in the system
- Keep the pressure loss as small as possible
- Note the mounting position of the flowmeter
- Min/max flow should be in the linear range of the selected flowmeter
- Clean the system at appropriate intervals
- Avoid electrical current peaks
- Incorrect cabling of power supply +, signal and ground will destroy the flowmeter
- Do not mechanically load electrical contacts
- Avoid moisture on the electrical contacts
- Avoid stray pick-up via the cable (Do not lay cables in parallel with high current loads)

# Measurement Curve FHKU G1/4" Ø2.00mm High Flow

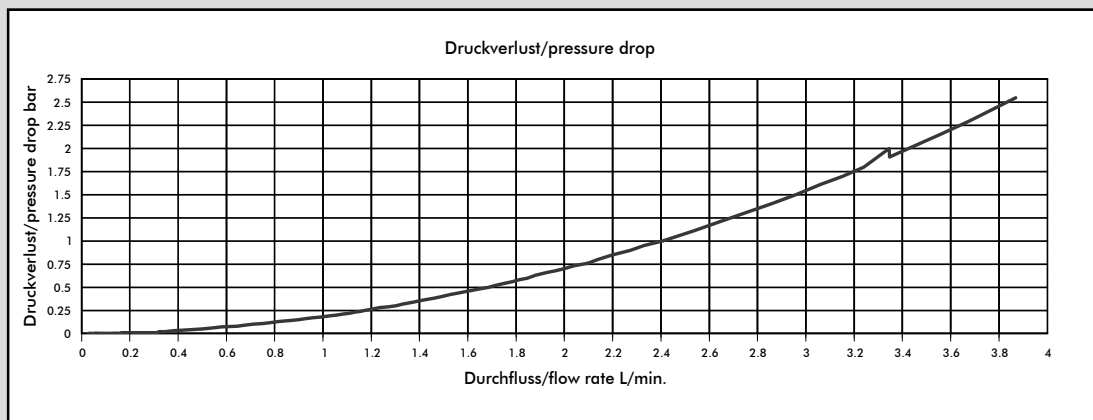
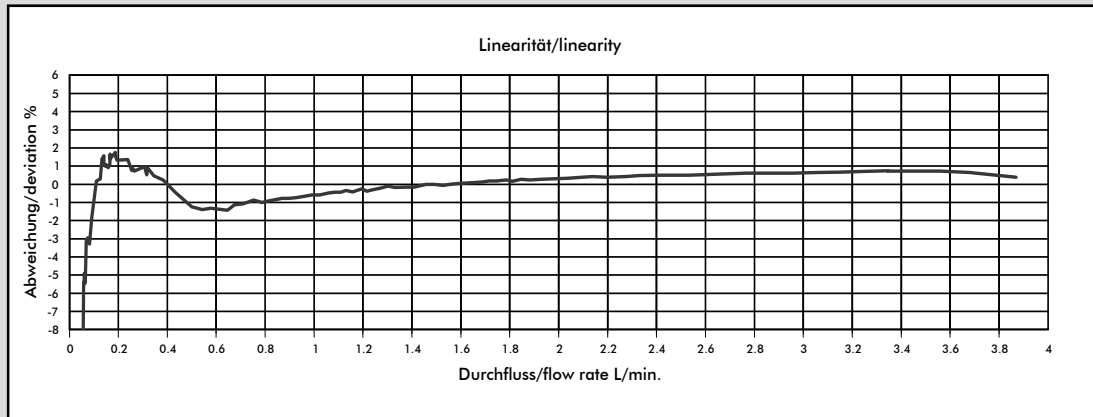

Medium: Water / max. Pressure: 3.3 bar

Number of magnets	Nozzle size	Pulses/Litres	Gramm/Puls	Recommended min. flow rate at [l/min]	Flow rate at 1900 rpm [l/min]
2	Ø 2.00 mm	1013	0.98	0.110	1.87
4	Ø 2.00 mm	2026	0.49	0.110	1.87

Part number:

Nozzle Ø 2.0mm with 2 Magnets: #938-1220-FK342

Nozzle Ø 2.0mm with 4 Magnets: #938-1220-FK344

**The values specified must be considered as approximate values.**

**The number of pulses per litre may differ depending on medium and installation.**

**We recommend to calibrate the number of pulses per litre in line with the complete installation.**

## MEASUREMENT TIPS

- Ensure that there is no fast-pulsatory movement of the media
- Ensure that there are no reverse pressure surges
- Ensure that there is no air in the system
- Keep the pressure loss as small as possible
- Note the mounting position of the flowmeter
- Min/max flow should be in the linear range of the selected flowmeter
- Clean the system at appropriate intervals
- Avoid electrical current peaks
- Incorrect cabling of power supply +, signal and ground will destroy the flowmeter
- Do not mechanically load electrical contacts
- Avoid moisture on the electrical contacts
- Avoid stray pick-up via the cable (Do not lay cables in parallel with high current loads)

# Measurement Curve FHKU G1/4" Ø2.50mm High Flow

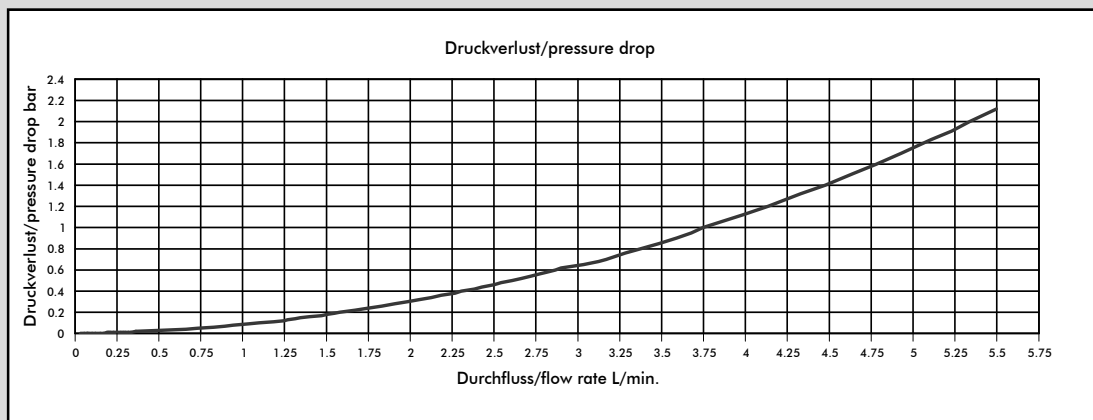
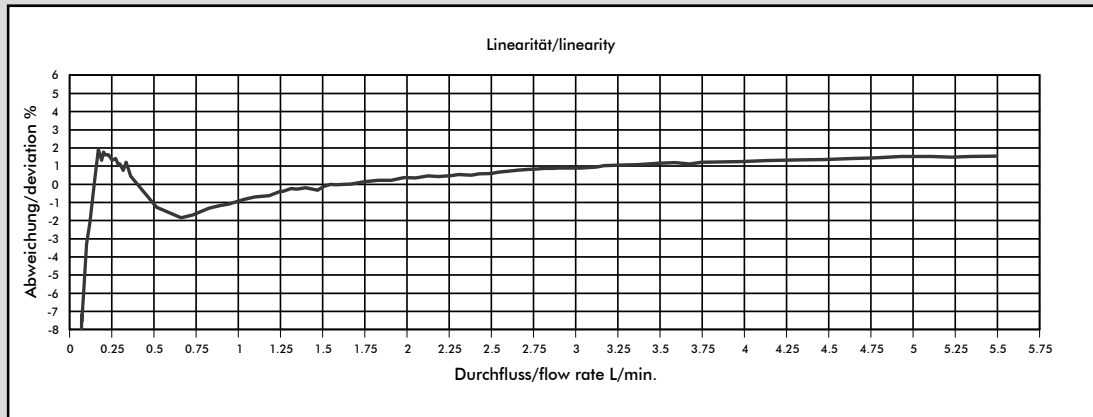

Medium: Water / max. Pressure: 3.3 bar

Number of magnets	Nozzle size	Pulses/Litres	Gramm/Puls	Recommended min. flow rate at [l/min]	Flow rate at 1900 rpm [l/min]
2	Ø 2.50 mm	754	1.32	0.067	2.52
4	Ø 2.50 mm	1508	0.66	0.067	2.52

Part number:

Nozzle Ø 2.5mm with 2 Magnets: #938-1225-FK342

Nozzle Ø 2.5mm with 4 Magnets: #938-1225-FK344

**The values specified must be considered as approximate values.**

**The number of pulses per litre may differ depending on medium and installation.**

**We recommend to calibrate the number of pulses per litre in line with the complete installation.**

## MEASUREMENT TIPS

- Ensure that there is no fast-pulsatory movement of the media
- Ensure that there are no reverse pressure surges
- Ensure that there is no air in the system
- Keep the pressure loss as small as possible
- Note the mounting position of the flowmeter
- Min/max flow should be in the linear range of the selected flowmeter
- Clean the system at appropriate intervals
- Avoid electrical current peaks
- Incorrect cabling of power supply +, signal and ground will destroy the flowmeter
- Do not mechanically load electrical contacts
- Avoid moisture on the electrical contacts
- Avoid stray pick-up via the cable (Do not lay cables in parallel with high current loads)

# Measurement Curve FHKU G1/4" Ø3.00mm High Flow

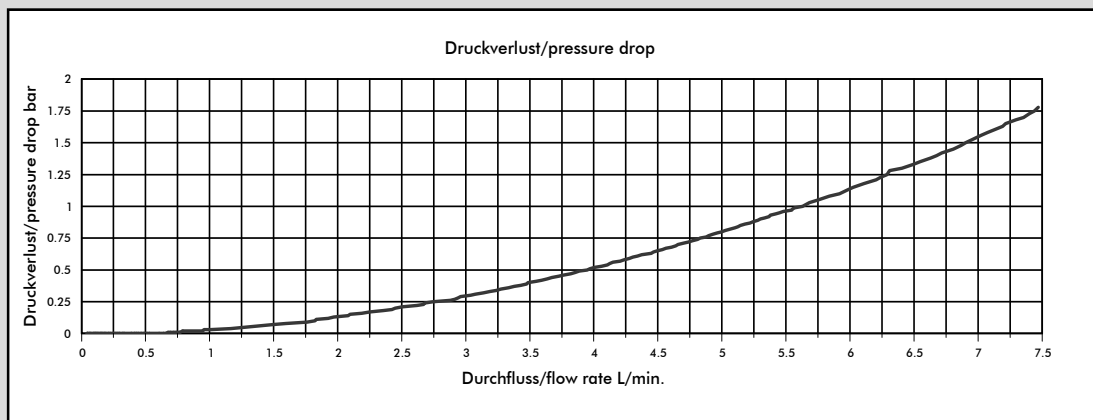
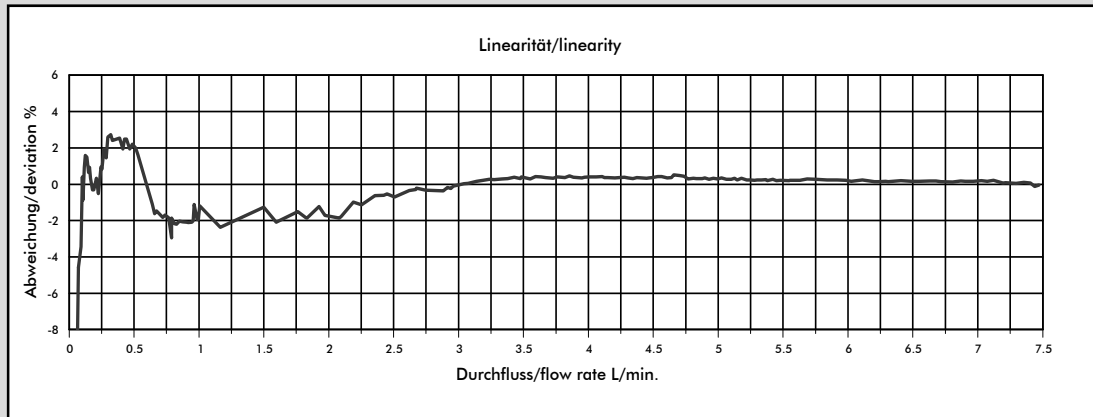

Medium: Water / max. Pressure: 3.3 bar

Number of magnets	Nozzle size	Pulses/Litres	Gramm/Puls	Recommended min. flow rate at [l/min]	Flow rate at 1900 rpm [l/min]
2	Ø 3.00 mm	527	1.74	0.130	3.32
4	Ø 3.00 mm	1054	0.87	0.130	3.32

Part number:

Nozzle Ø 3.0mm with 2 Magnets: #938-1230-FK342

Nozzle Ø 3.0mm with 4 Magnets: #938-1230-FK344

**The values specified must be considered as approximate values.**

**The number of pulses per litre may differ depending on medium and installation.**

**We recommend to calibrate the number of pulses per litre in line with the complete installation.**

## MEASUREMENT TIPS

- Ensure that there is no fast-pulsatory movement of the media
- Ensure that there are no reverse pressure surges
- Ensure that there is no air in the system
- Keep the pressure loss as small as possible
- Note the mounting position of the flowmeter
- Min/max flow should be in the linear range of the selected flowmeter
- Clean the system at appropriate intervals
- Avoid electrical current peaks
- Incorrect cabling of power supply +, signal and ground will destroy the flowmeter
- Do not mechanically load electrical contacts
- Avoid moisture on the electrical contacts
- Avoid stray pick-up via the cable (Do not lay cables in parallel with high current loads)



# Measurement Curve FHKU G1/4" Ø4.00mm High Flow

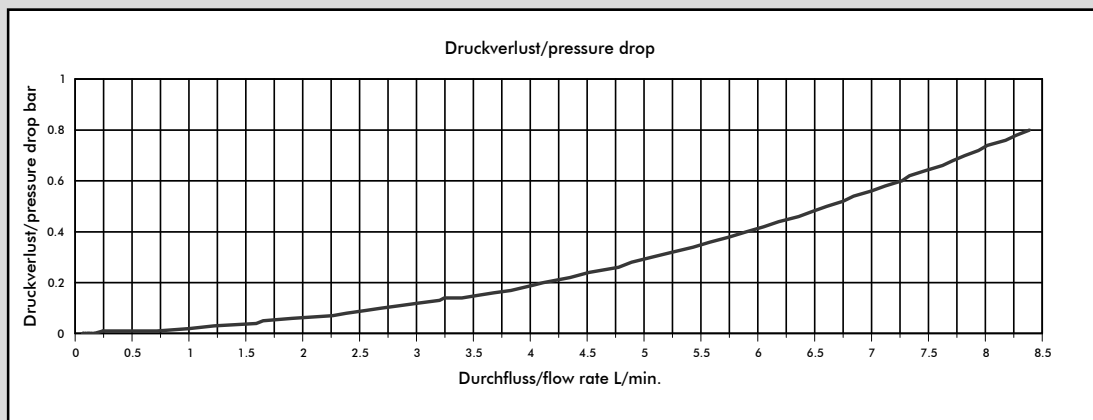
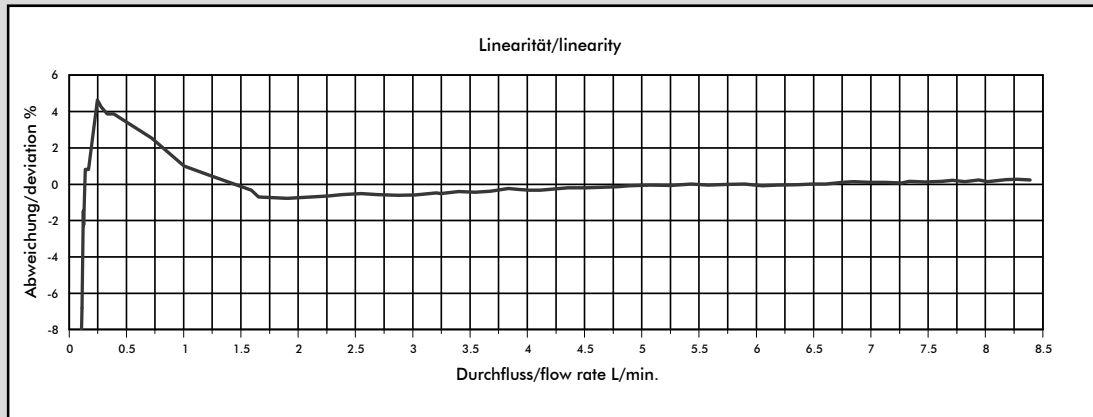

Medium: Water / max. Pressure: 3.3 bar

Number of magnets	Nozzle size	Pulses/Litres	Gramm/Puls	Recommended min. flow rate at [l/min]	Flow rate at 1900 rpm [l/min]
2	Ø 4.00 mm	382	2.61	0.113	4.97
4	Ø 4.00 mm	764	1.30	0.113	4.97

Part number:

Nozzle Ø 4.0mm with 2 Magnets: #938-1240-FK342

Nozzle Ø 4.0mm with 4 Magnets: #938-1240-FK344

**The values specified must be considered as approximate values.**

**The number of pulses per litre may differ depending on medium and installation.**

**We recommend to calibrate the number of pulses per litre in line with the complete installation.**

## MEASUREMENT TIPS

- Ensure that there is no fast-pulsatory movement of the media
- Ensure that there are no reverse pressure surges
- Ensure that there is no air in the system
- Keep the pressure loss as small as possible
- Note the mounting position of the flowmeter
- Min/max flow should be in the linear range of the selected flowmeter
- Clean the system at appropriate intervals
- Avoid electrical current peaks
- Incorrect cabling of power supply +, signal and ground will destroy the flowmeter
- Do not mechanically load electrical contacts
- Avoid moisture on the electrical contacts
- Avoid stray pick-up via the cable (Do not lay cables in parallel with high current loads)

# Measurement Curve FHKU G1/4" Ø5.60mm High Flow

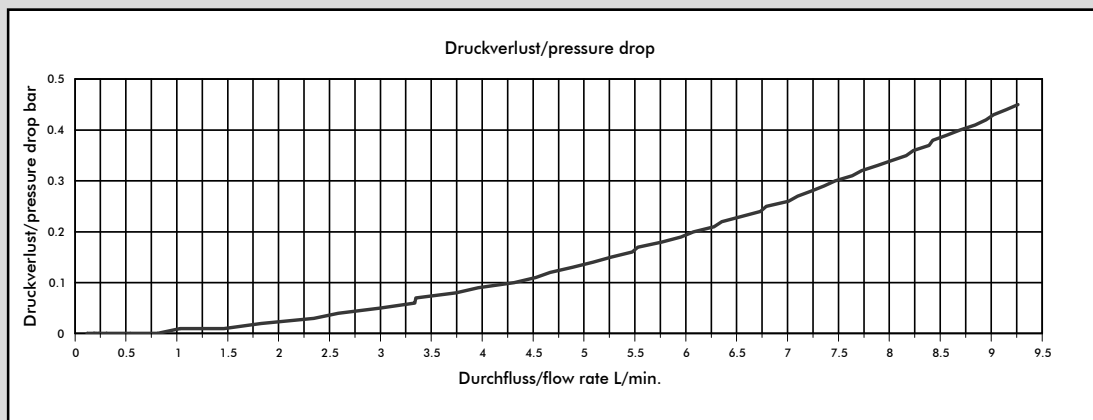
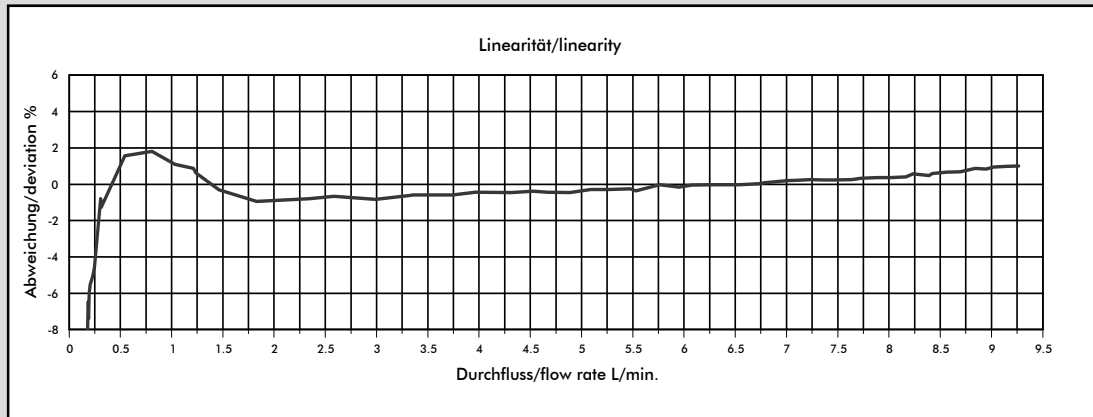

Medium: Water / max. Pressure: 3.3 bar

Number of magnets	Nozzle size	Pulses/Litres	Gramm/Puls	Recommended min. flow rate at [l/min]	Flow rate at 1900 rpm [l/min]
2	Ø 5.60 mm	256	3.90	0.180	7.42
4	Ø 5.60 mm	512	1.95	0.180	7.42

Part number:

Nozzle Ø 5.6mm with 2 Magnets: #938-1256-K342

Nozzle Ø 5.6mm with 4 Magnets: #938-1256-K344

**The values specified must be considered as approximate values.**

**The number of pulses per litre may differ depending on medium and installation.**

**We recommend to calibrate the number of pulses per litre in line with the complete installation.**

## MEASUREMENT TIPS

- Ensure that there is no fast-pulsatory movement of the media
- Ensure that there are no reverse pressure surges
- Ensure that there is no air in the system
- Keep the pressure loss as small as possible
- Note the mounting position of the flowmeter
- Min/max flow should be in the linear range of the selected flowmeter
- Clean the system at appropriate intervals
- Avoid electrical current peaks
- Incorrect cabling of power supply +, signal and ground will destroy the flowmeter
- Do not mechanically load electrical contacts
- Avoid moisture on the electrical contacts
- Avoid stray pick-up via the cable (Do not lay cables in parallel with high current loads)