

# DATA SHEET

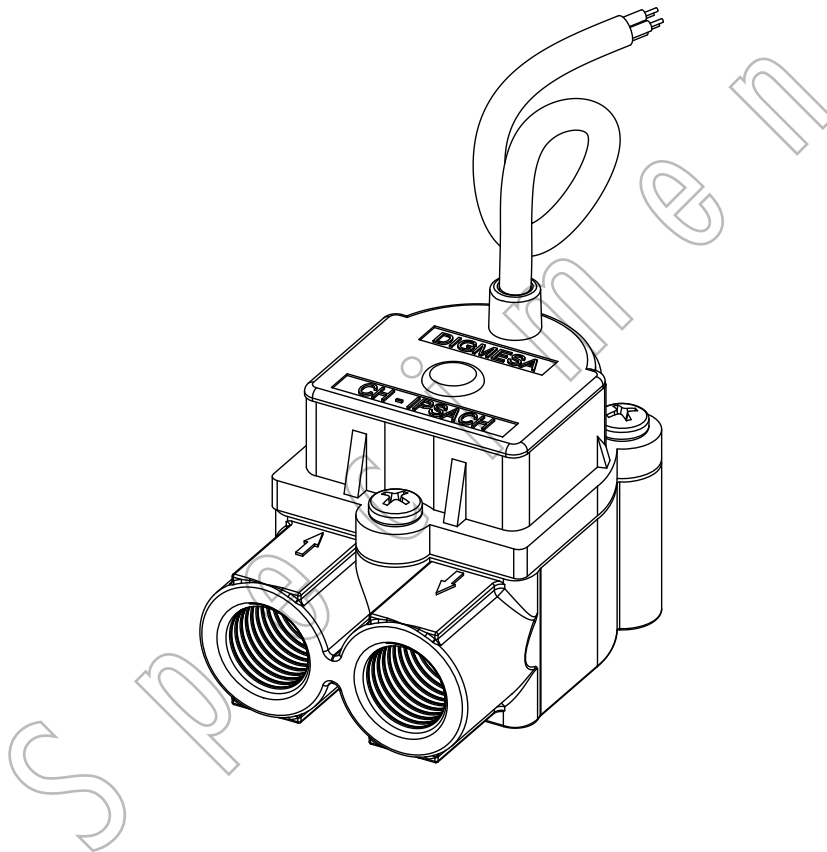

**DIGIMESA**<sup>+</sup>  
CHOOSE THE ORIGINAL

---

FHK G1/4" CombiSensor analog  
Part number: 937-15xx/xTL51x

Digimesa AG, Keltenstrasse 31, CH-2563 Ipsach / Switzerland  
Phone +41 (32) 332 77 77, Fax +41 (32) 332 77 88

[www.digimesa.com](http://www.digimesa.com)

Version 01 FHK G1/4" CombiSensor analog 937-15xx/xTL51x GB Seite 1-12

# General Description

The CombiSensor has been designed for all applications where Flow, Temperature and Conductivity must be measured, and in a very compact form. The device is therefore adequate for the waterfilter industry (e.g. compact RO equipment) The "CombiSensor analogue" comes with one pulse output for flow and two current outputs for conductivity and temperature.

**Specific applications:** The CombiSensor calculates the temperature compensation of the conductivity value, based on the measured temperature and a compensation factor 2.25% per °C. The conductivity measurement value is therefore "temperature-compensated".

## Approvals / Standards

EN55014-1:00+A1:01+A2:02, EN61000-6-3:01+A11:04, IEC61000-6-3:06(ed.2.0), EN61000-3-2:06, IEC61000-3-2:05(ed.3.0), EN61000-3-3:95+A1:01+A2:05, IEC61000-3-3:94+A1:01+A2:05(Cons.ed 1.2), EN55014-2:97+A1:01, EN61000-6-1:01, IEC61000-6-1:05(ed.2)



## Material:

Housing:	PBT 35%GF
Bearing pin:	Inox 1.4305
Probes:	Temperature Inox 1.4598 Conductivity Inox 1.4598
Nozzle:	Ø 1.0, 1.2, 2.0, 2.5mm PPS 40%GF
Nozzle:	Ø 3.0, 4.0mm Inox 1.4305
Nozzle:	Ø 3.3, 5.6mm like housing
O-ring:	MVQ (Silikon) FPM (Viton) / EPDM on request
Turbine:	PVDF 2 Magnets
Magnete:	Ceramic Sr Fe O (in contact with the medium)
Screws:	PT-screws (Phillips cross recessed)

## Measurement characteristics:

<u>Flow rate:</u>	0.041 - 15 l/min depending on the nozzle diameter
Nozzle size:	Ø 1.0, 1.2, 2.0, 2.5, 3.0, 3.3, 4.0, 5.6mm
Continuous operation:	< 500 rpm
Measuring accuracy:	+/- 2.0%
Repetition:	< +/- 0.25%
Pulse output:	square wave
<u>Conductivity:</u>	0 - 20'000 µS/cm
Measuring ranges:	see page 4
Measuring accuracy:	± 3.0% FS (Full Scale)
Response time:	0.5 sec.
Signal output:	4 - 20mA
<u>Temperature:</u>	0 - 65 °C
Measuring accuracy:	± 0.5 °C (under flow condition)
Response time probe:	7 sec.
Signal output:	4 - 20mA

## Electrical connection ratings:

Power supply:	+ 10VDC to + 24VDC (+/-10%)
Consumption:	max. 65mA
Voltage max.:	VDC-6V on 4-20mA output
Connections:	5-Pol Cable AWG 24 (open wire) 0.6 meter

## Technical data:

Temperature range:	-10°C to +65°C 14°F to 149°F
Pressure range:	20 bar at 20°C 290 psi / 68°F
Mounting position:	Horizontal *

## Dimensions in mm:

2 x inner thread G1/4"

Cable 5 wires

\*Horizontal position is, when this side is facing up.

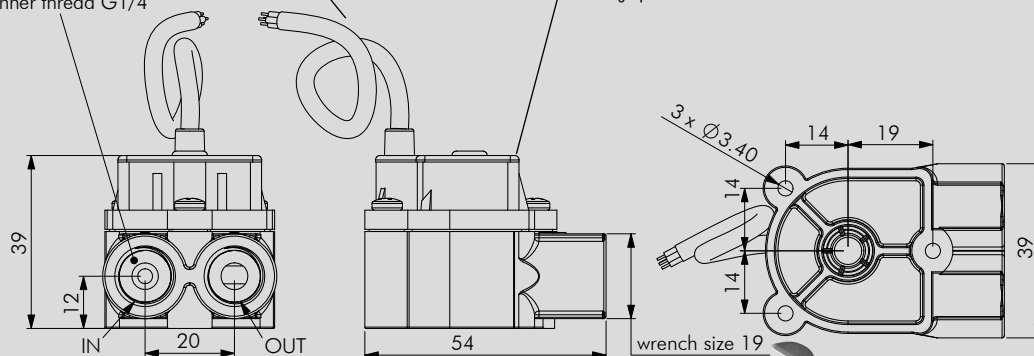

## CABLE PINOUT

Cable color	Description
Red	+ 10VDC to + 24VDC
Black	GND (Sensor Ground)
Brown	Pulse
Orange	Conductivity (4-20 mA)
Yellow	Temperature (4-20 mA)

## MEASUREMENT

The flow measurement may differ depending on medium and installation. We recommend to calibrate the number of pulses per liter in line with the complete installation"

## RESISTANCE

Special regulations which must be complied with by the flowmeter manufacturer apply to each country, e.g. CE, NSF, FDA and SK. The various media flowing through the flowmeter differ from application to application. You are advised to enquire with the medium manufacturer as to whether the entire installation and the flowmeter are resistant to the medium itself (see Material)!

# Pulse output (Flow)

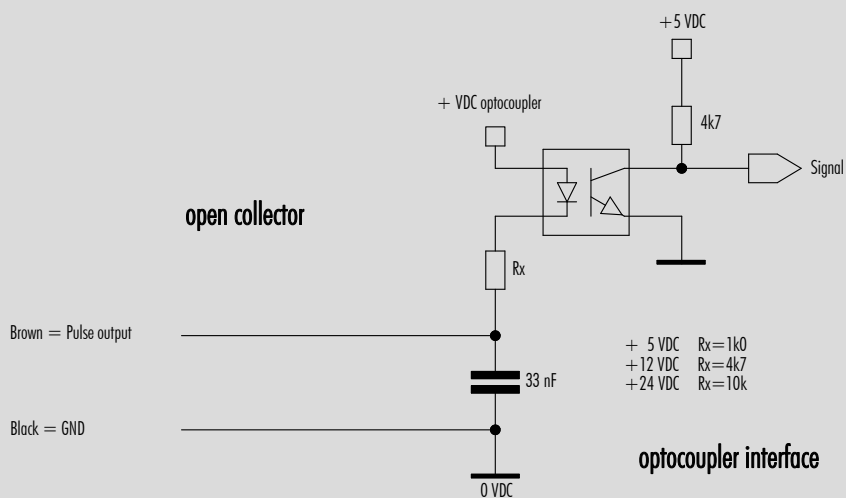
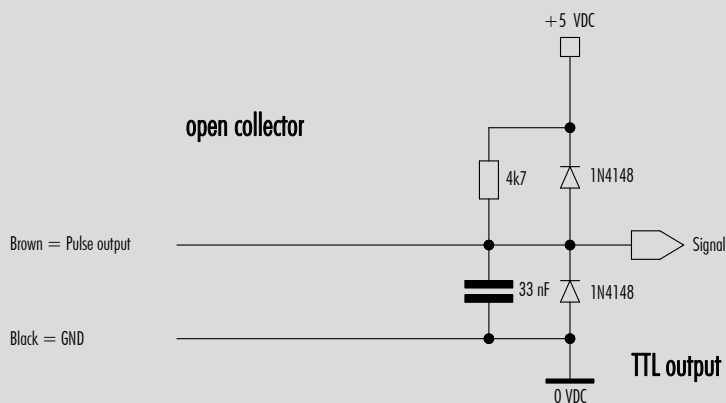
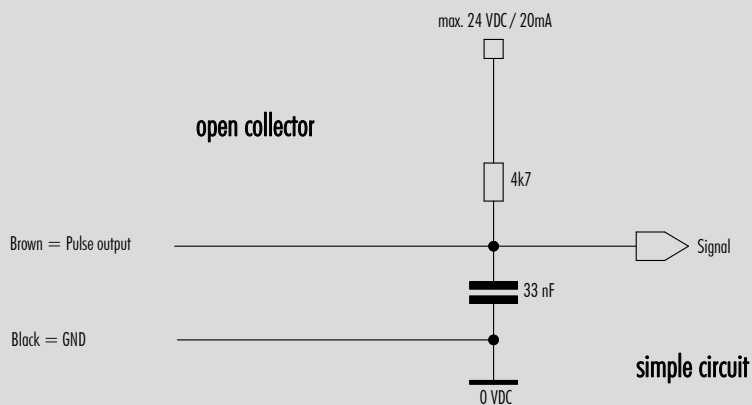

# Conductivity and Temperature Ranges

## Conductivity:

Measurement Accuracy:  $\pm 3.0\%$  Full Scale (FS)  
 Response time: 0.5 sec.  
 Temp. comp. factor: 2.25% / °C  
 Reference Temperature: 25°C  
 Signal output: 4 - 20mA  
 Measurement range: 0 - 50  $\mu\text{S}/\text{cm}$

## Temperature:

Measuring accuracy:  $\pm 0.5\text{ }^\circ\text{C}$   
 (under flow condition)  
 Response time probe: 7 sec.  
 Signal output: 4 - 20mA  
 Measurement range: 0 - 65 °C

## Analog current output:

Zero current: 4mA  
 Full scale span (FSS): 16mA (4 to 20 mA)  
 Resolution:  $\sim 0.006\text{ mA}$   
 Load Resistance: 0 to 900  $\Omega$  (@24VDC)  
 Max. voltage: VDC -6V  
 (For eg. 4V if VDC=10V)

On request other ranges or compensation are also available.

For example:

0 - 200  $\mu\text{S}/\text{cm}$

0 - 300  $\mu\text{S}/\text{cm}$

0 - 2 mS/cm

0 - 20 mS/cm

## Measurement curve for reference

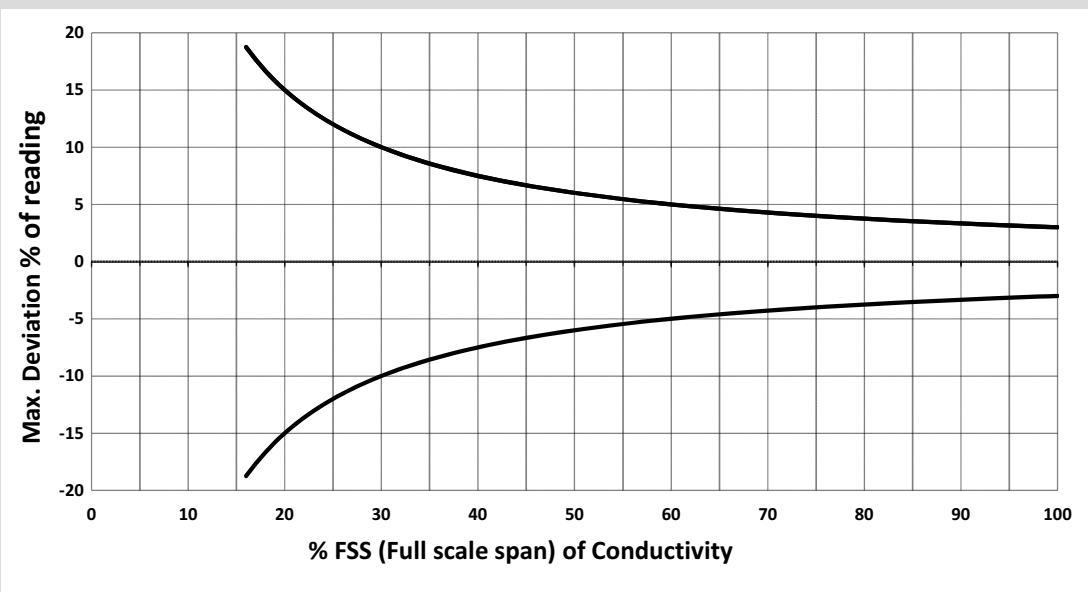

Notes: Linearity is referenced to temperature uncompensated effective conductivity of medium.

## MEASUREMENT TIPS Conductivity:

Air bubbles in the sensor can deteriorate conductivity measurement values. Make sure you did well evacuate the air from the sensor.

For measuring accurate temperature compensated conductivity, flowing medium guarantees optimal temperature condition for the probe.

To limit the heating from the current outputs, lower supply voltages are preferable (e.g. 12V).

# Flow Measurement Curve FHK Ø1.00mm (#937-1510/FTL51)

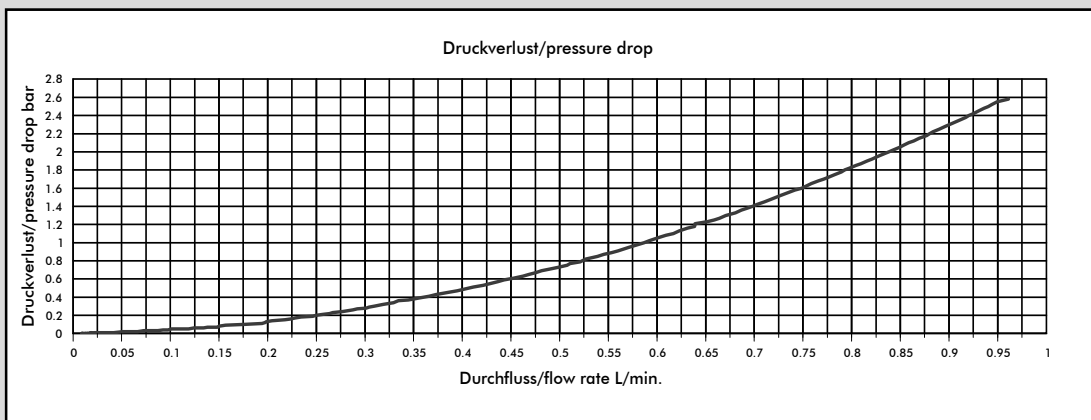
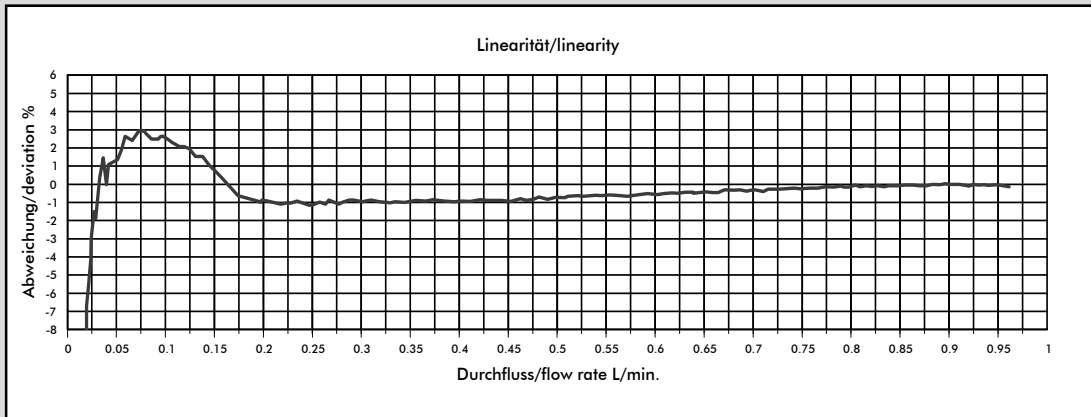

Medium: Water / max. Pressure: 3.3 bar

Nozzle size	Pulses/litre	g/pulse	min. flow rate in [litres/min] at linear start	max. flow rate in [litres/min]	Pressure loss in [bar]
Ø 1.00 mm	2223	0.45	0.027	0.58	1.0
Ø 1.20 mm	1787	0.56	0.032	0.77	1.0
Ø 2.00 mm	1013	0.98	0.111	2.32	1.0
Ø 2.50 mm	754	1.32	0.067	2.74	0.6
Ø 3.00 mm	572	1.75	0.137	4.88	1.0
Ø 3.30 mm	509	1.96	0.140	5.36	1.0
Ø 4.00 mm	382	2.61	0.111	7.26	1.0
Ø 5.60 mm	256	3.91	0.180	8.30	0.9

**The values specified must be considered as approximate values.**

**The number of pulses per litre may differ depending on medium and installation.**

**We recommend to calibrate the number of pulses per litre in line with the complete installation.**

## MEASUREMENT TIPS

- Ensure that there is no fast-pulsatory movement of the media
- Ensure that there are no reverse pressure surges
- Ensure that there is no air in the system
- Keep the pressure loss as small as possible
- Note the mounting position of the flowmeter
- Min/max flow should be in the linear range of the selected flowmeter
- Clean the system at appropriate intervals
- Avoid electrical current peaks
- Incorrect cabling of power supply +, signal and ground will destroy the flowmeter
- Do not mechanically load electrical contacts
- Avoid moisture on the electrical contacts
- Avoid stray pick-up via the cable (Do not lay cables in parallel with high current loads)

# Flow Measurement Curve FHK Ø1.20mm (#937-1512/FTL51)

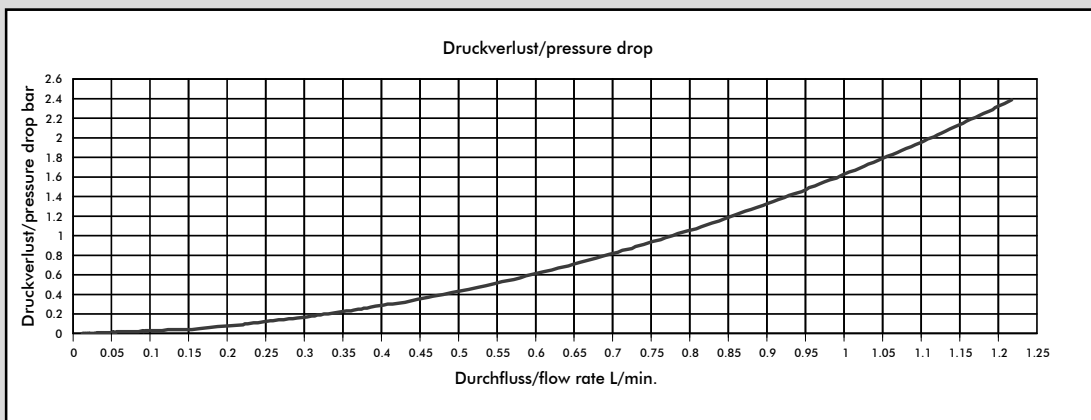
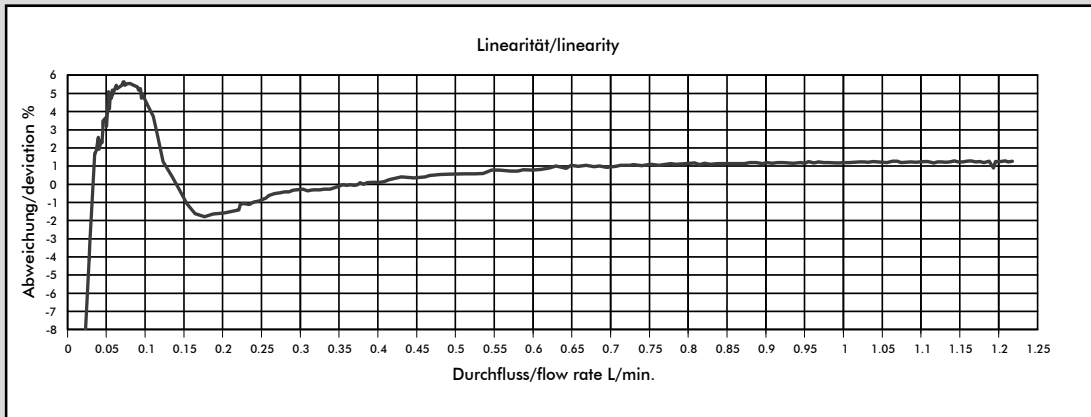

Medium: Water / max. Pressure: 3.3 bar

Nozzle size	Pulses/litre	g/pulse	min. flow rate in [litres/min] at linear start	max. flow rate in [litres/min]	Pressure loss in [bar]
Ø 1.00 mm	2223	0.45	0.027	0.58	1.0
Ø 1.20 mm	1787	0.56	0.032	0.77	1.0
Ø 2.00 mm	1013	0.98	0.111	2.32	1.0
Ø 2.50 mm	754	1.32	0.067	2.74	0.6
Ø 3.00 mm	572	1.75	0.137	4.88	1.0
Ø 3.30 mm	509	1.96	0.140	5.36	1.0
Ø 4.00 mm	382	2.61	0.111	7.26	1.0
Ø 5.60 mm	256	3.91	0.180	8.30	0.9

**The values specified must be considered as approximate values.**

**The number of pulses per litre may differ depending on medium and installation.**

**We recommend to calibrate the number of pulses per litre in line with the complete installation.**

## MEASUREMENT TIPS

- Ensure that there is no fast-pulsatory movement of the media
- Ensure that there are no reverse pressure surges
- Ensure that there is no air in the system
- Keep the pressure loss as small as possible
- Note the mounting position of the flowmeter
- Min/max flow should be in the linear range of the selected flowmeter
- Clean the system at appropriate intervals
- Avoid electrical current peaks
- Incorrect cabling of power supply +, signal and ground will destroy the flowmeter
- Do not mechanically load electrical contacts
- Avoid moisture on the electrical contacts
- Avoid stray pick-up via the cable (Do not lay cables in parallel with high current loads)

# Flow Measurement Curve FHK Ø2.00mm (#937-1520/FTL51)

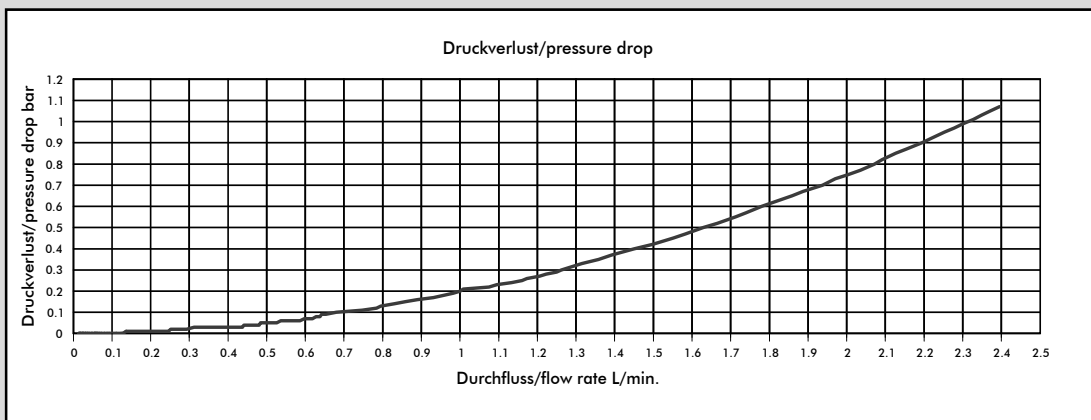
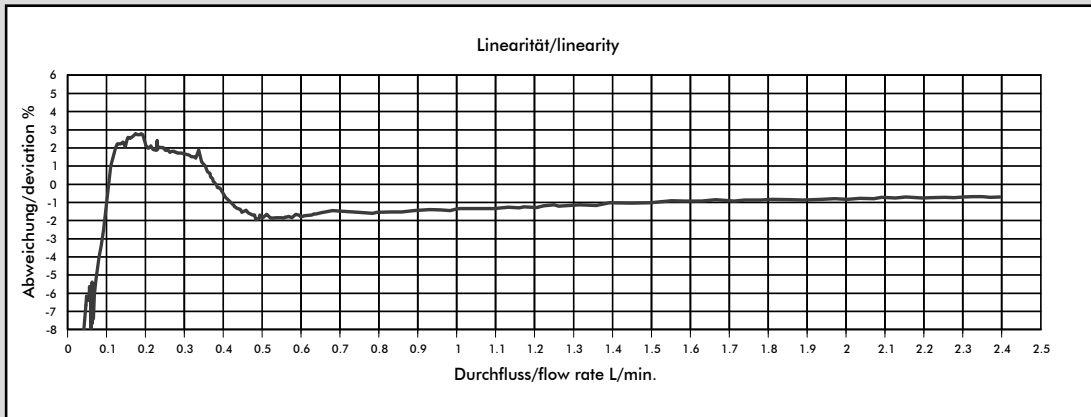

Medium: Water / max. Pressure: 3.3 bar

Nozzle size	Pulses/litre	g/pulse	min. flow rate in [litres/min] at linear start	max. flow rate in [litres/min]	Pressure loss in [bar]
Ø 1.00 mm	2223	0.45	0.027	0.58	1.0
Ø 1.20 mm	1787	0.56	0.032	0.77	1.0
Ø 2.00 mm	1013	0.98	0.111	2.32	1.0
Ø 2.50 mm	754	1.32	0.067	2.74	0.6
Ø 3.00 mm	572	1.75	0.137	4.88	1.0
Ø 3.30 mm	509	1.96	0.140	5.36	1.0
Ø 4.00 mm	382	2.61	0.111	7.26	1.0
Ø 5.60 mm	256	3.91	0.180	8.30	0.9

**The values specified must be considered as approximate values.**

**The number of pulses per litre may differ depending on medium and installation.**

**We recommend to calibrate the number of pulses per litre in line with the complete installation.**

## MEASUREMENT TIPS

- Ensure that there is no fast-pulsatory movement of the media
- Ensure that there are no reverse pressure surges
- Ensure that there is no air in the system
- Keep the pressure loss as small as possible
- Note the mounting position of the flowmeter
- Min/max flow should be in the linear range of the selected flowmeter
- Clean the system at appropriate intervals
- Avoid electrical current peaks
- Incorrect cabling of power supply +, signal and ground will destroy the flowmeter
- Do not mechanically load electrical contacts
- Avoid moisture on the electrical contacts
- Avoid stray pick-up via the cable (Do not lay cables in parallel with high current loads)

# Flow Measurement Curve FHK Ø2.50mm (#937-1525/FTL51)

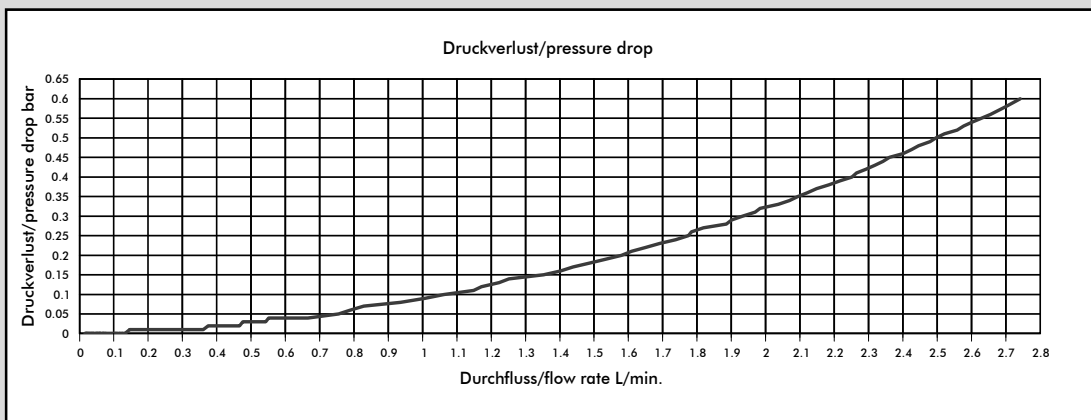
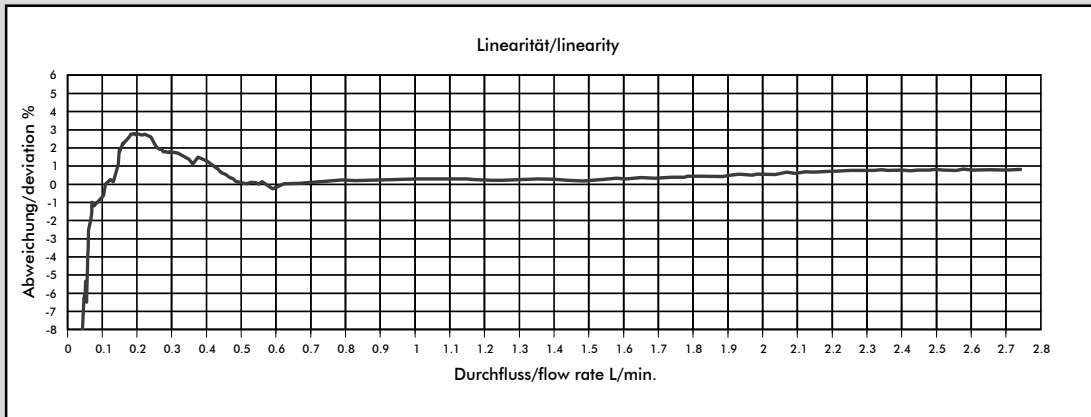

Medium: Water / max. Pressure: 3.3 bar

Nozzle size	Pulses/litre	g/pulse	min. flow rate in [litres/min] at linear start	max. flow rate in [litres/min]	Pressure loss in [bar]
Ø 1.00 mm	2223	0.45	0.027	0.58	1.0
Ø 1.20 mm	1787	0.56	0.032	0.77	1.0
Ø 2.00 mm	1013	0.98	0.111	2.32	1.0
Ø 2.50 mm	754	1.32	0.067	2.74	0.6
Ø 3.00 mm	572	1.75	0.137	4.88	1.0
Ø 3.30 mm	509	1.96	0.140	5.36	1.0
Ø 4.00 mm	382	2.61	0.111	7.26	1.0
Ø 5.60 mm	256	3.91	0.180	8.30	0.9

**The values specified must be considered as approximate values.**

**The number of pulses per litre may differ depending on medium and installation.**

**We recommend to calibrate the number of pulses per litre in line with the complete installation.**

## MEASUREMENT TIPS

- Ensure that there is no fast-pulsatory movement of the media
- Ensure that there are no reverse pressure surges
- Ensure that there is no air in the system
- Keep the pressure loss as small as possible
- Note the mounting position of the flowmeter
- Min/max flow should be in the linear range of the selected flowmeter
- Clean the system at appropriate intervals
- Avoid electrical current peaks
- Incorrect cabling of power supply +, signal and ground will destroy the flowmeter
- Do not mechanically load electrical contacts
- Avoid moisture on the electrical contacts
- Avoid stray pick-up via the cable (Do not lay cables in parallel with high current loads)



# Flow Measurement Curve FHK Ø3.00mm (#937-1530/TL51)

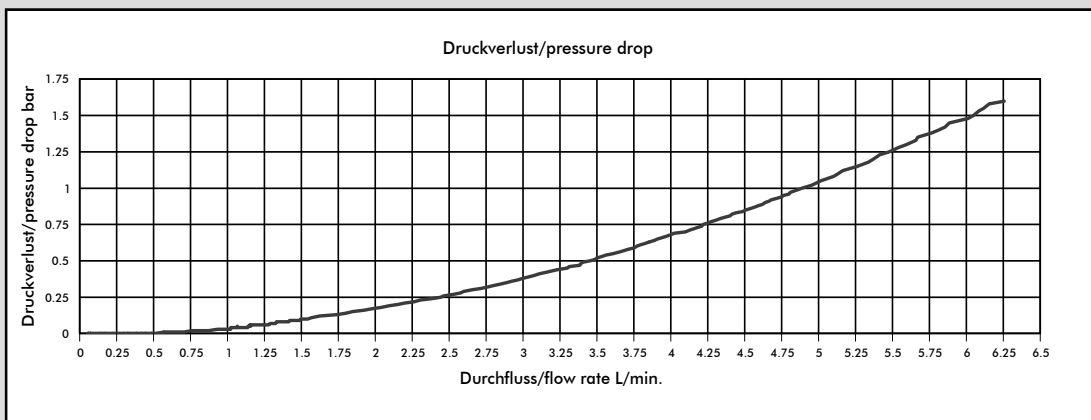
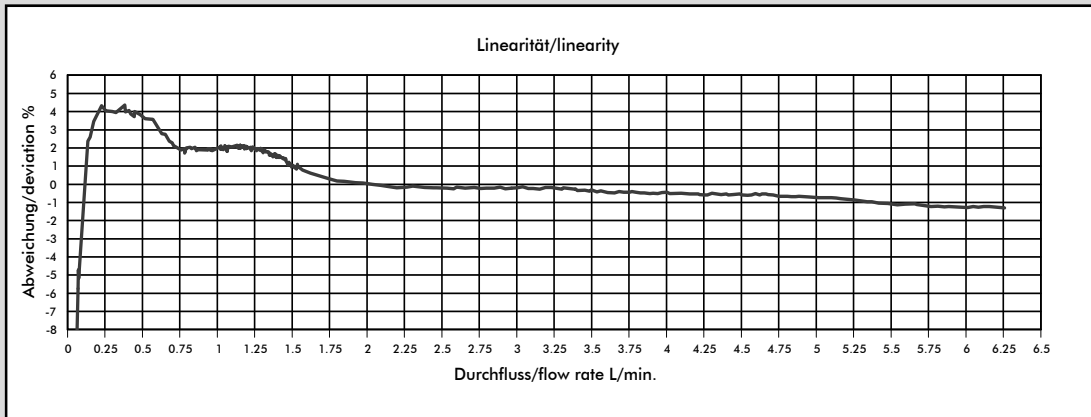

Medium: Water / max. Pressure: 3.3 bar

Nozzle size	Pulses/litre	g/pulse	min. flow rate in [litres/min] at linear start	max. flow rate in [litres/min]	Pressure loss in [bar]
Ø 1.00 mm	2223	0.45	0.027	0.58	1.0
Ø 1.20 mm	1787	0.56	0.032	0.77	1.0
Ø 2.00 mm	1013	0.98	0.111	2.32	1.0
Ø 2.50 mm	754	1.32	0.067	2.74	0.6
Ø 3.00 mm	572	1.75	0.137	4.88	1.0
Ø 3.30 mm	509	1.96	0.140	5.36	1.0
Ø 4.00 mm	382	2.61	0.111	7.26	1.0
Ø 5.60 mm	256	3.91	0.180	8.30	0.9

**The values specified must be considered as approximate values.**

**The number of pulses per litre may differ depending on medium and installation.**

**We recommend to calibrate the number of pulses per litre in line with the complete installation.**

## MEASUREMENT TIPS

- Ensure that there is no fast-pulsatory movement of the media
- Ensure that there are no reverse pressure surges
- Ensure that there is no air in the system
- Keep the pressure loss as small as possible
- Note the mounting position of the flowmeter
- Min/max flow should be in the linear range of the selected flowmeter
- Clean the system at appropriate intervals
- Avoid electrical current peaks
- Incorrect cabling of power supply +, signal and ground will destroy the flowmeter
- Do not mechanically load electrical contacts
- Avoid moisture on the electrical contacts
- Avoid stray pick-up via the cable (Do not lay cables in parallel with high current loads)

# Flow Measurement Curve FHK Ø3.30mm (#937-1533/TL51)

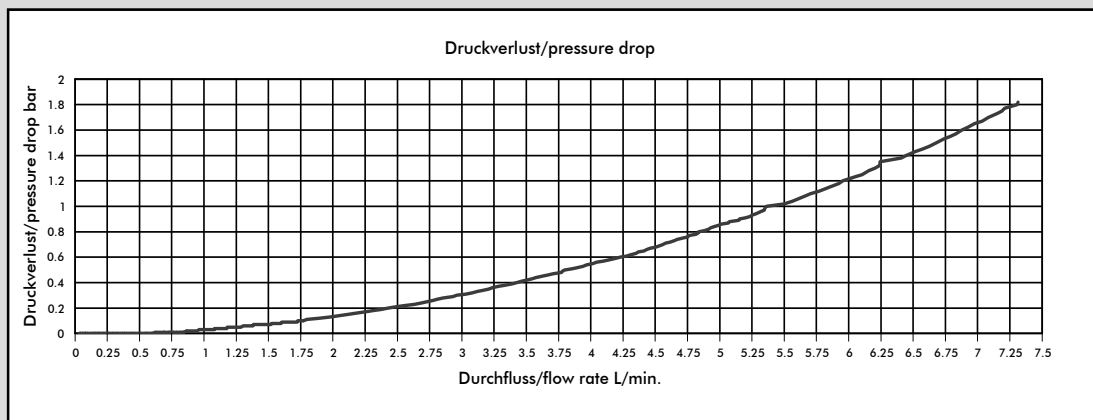
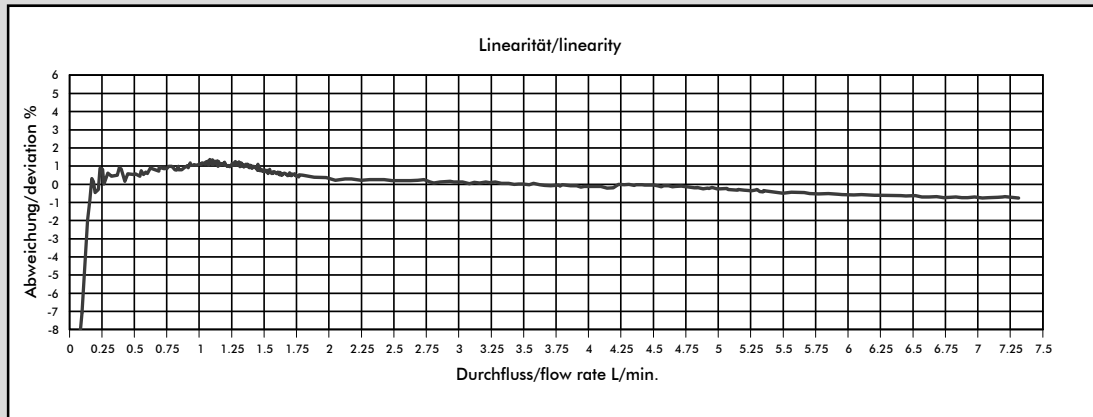

Medium: Water / max. Pressure: 3.3 bar

Nozzle size	Pulses/litre	g/pulse	min. flow rate in [litres/min] at linear start	max. flow rate in [litres/min]	Pressure loss in [bar]
Ø 1.00 mm	2223	0.45	0.027	0.58	1.0
Ø 1.20 mm	1787	0.56	0.032	0.77	1.0
Ø 2.00 mm	1013	0.98	0.111	2.32	1.0
Ø 2.50 mm	754	1.32	0.067	2.74	0.6
Ø 3.00 mm	572	1.75	0.137	4.88	1.0
Ø 3.30 mm	509	1.96	0.140	5.36	1.0
Ø 4.00 mm	382	2.61	0.111	7.26	1.0
Ø 5.60 mm	256	3.91	0.180	8.30	0.9

**The values specified must be considered as approximate values.**

**The number of pulses per litre may differ depending on medium and installation.**

**We recommend to calibrate the number of pulses per litre in line with the complete installation.**

## MEASUREMENT TIPS

- Ensure that there is no fast-pulsatory movement of the media
- Ensure that there are no reverse pressure surges
- Ensure that there is no air in the system
- Keep the pressure loss as small as possible
- Note the mounting position of the flowmeter
- Min/max flow should be in the linear range of the selected flowmeter
- Clean the system at appropriate intervals
- Avoid electrical current peaks
- Incorrect cabling of power supply +, signal and ground will destroy the flowmeter
- Do not mechanically load electrical contacts
- Avoid moisture on the electrical contacts
- Avoid stray pick-up via the cable (Do not lay cables in parallel with high current loads)

# Flow Measurement Curve FHK Ø4.00mm (#937-1540/TL51)

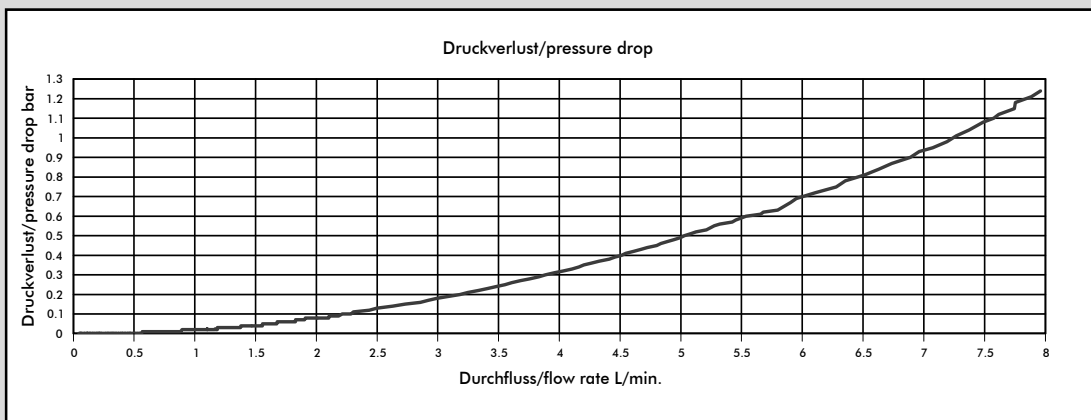
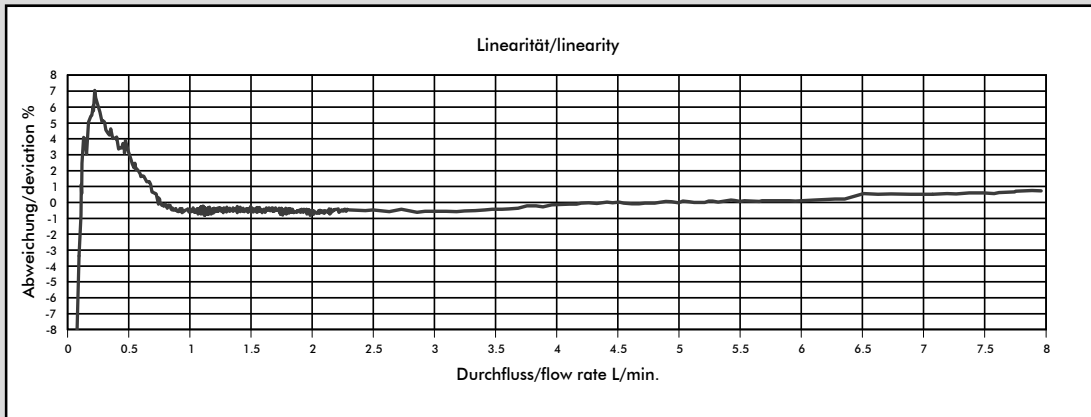

Medium: Water / max. Pressure: 3.3 bar

Nozzle size	Pulses/litre	g/pulse	min. flow rate in [litres/min] at linear start	max. flow rate in [litres/min]	Pressure loss in [bar]
Ø 1.00 mm	2223	0.45	0.027	0.58	1.0
Ø 1.20 mm	1787	0.56	0.032	0.77	1.0
Ø 2.00 mm	1013	0.98	0.111	2.32	1.0
Ø 2.50 mm	754	1.32	0.067	2.74	0.6
Ø 3.00 mm	572	1.75	0.137	4.88	1.0
Ø 3.30 mm	509	1.96	0.140	5.36	1.0
Ø 4.00 mm	382	2.61	0.111	7.26	1.0
Ø 5.60 mm	256	3.91	0.180	8.30	0.9

**The values specified must be considered as approximate values.**

**The number of pulses per litre may differ depending on medium and installation.**

**We recommend to calibrate the number of pulses per litre in line with the complete installation.**

## MEASUREMENT TIPS

- Ensure that there is no fast-pulsatory movement of the media
- Ensure that there are no reverse pressure surges
- Ensure that there is no air in the system
- Keep the pressure loss as small as possible
- Note the mounting position of the flowmeter
- Min/max flow should be in the linear range of the selected flowmeter
- Clean the system at appropriate intervals
- Avoid electrical current peaks
- Incorrect cabling of power supply +, signal and ground will destroy the flowmeter
- Do not mechanically load electrical contacts
- Avoid moisture on the electrical contacts
- Avoid stray pick-up via the cable (Do not lay cables in parallel with high current loads)

# Flow Measurement Curve FHK Ø5.60mm (#937-1556/TL51)

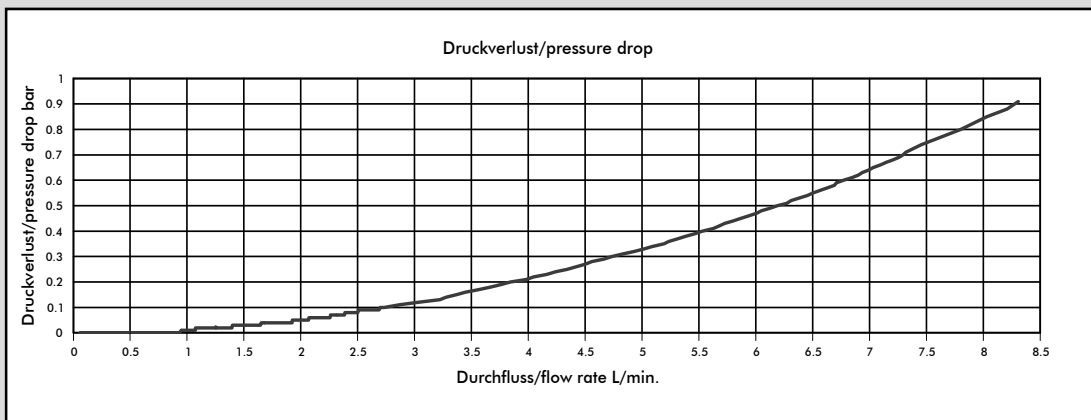
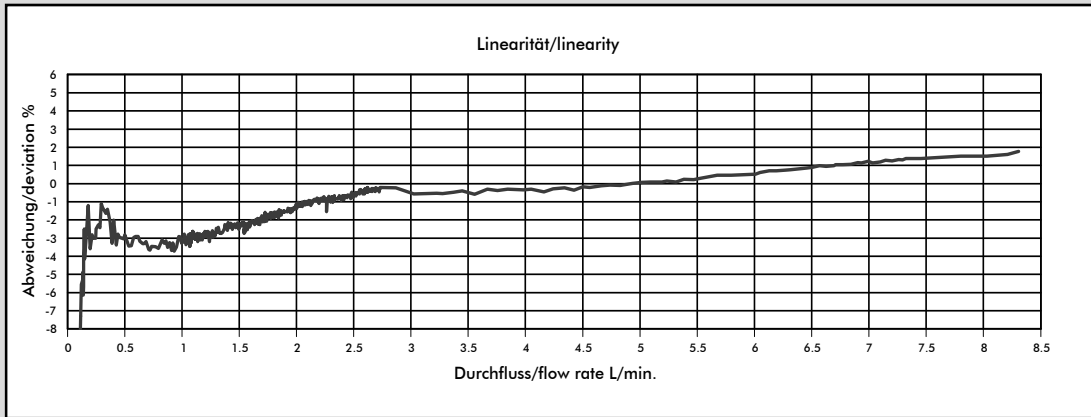

Medium: Water / max. Pressure: 3.3 bar

Nozzle size	Pulses/litre	g/pulse	min. flow rate in [litres/min] at linear start	max. flow rate in [litres/min]	Pressure loss in [bar]
Ø 1.00 mm	2223	0.45	0.027	0.58	1.0
Ø 1.20 mm	1787	0.56	0.032	0.77	1.0
Ø 2.00 mm	1013	0.98	0.111	2.32	1.0
Ø 2.50 mm	754	1.32	0.067	2.74	0.6
Ø 3.00 mm	572	1.75	0.137	4.88	1.0
Ø 3.30 mm	509	1.96	0.140	5.36	1.0
Ø 4.00 mm	382	2.61	0.111	7.26	1.0
Ø 5.60 mm	256	3.91	0.180	8.30	0.9

## MEASUREMENT TIPS

- Ensure that there is no fast-pulsatory movement of the media
- Ensure that there are no reverse pressure surges
- Ensure that there is no air in the system
- Keep the pressure loss as small as possible
- Note the mounting position of the flowmeter
- Min/max flow should be in the linear range of the selected flowmeter
- Clean the system at appropriate intervals
- Avoid electrical current peaks
- Incorrect cabling of power supply +, signal and ground will destroy the flowmeter
- Do not mechanically load electrical contacts
- Avoid moisture on the electrical contacts
- Avoid stray pick-up via the cable (Do not lay cables in parallel with high current loads)

**The values specified must be considered as approximate values.**

**The number of pulses per litre may differ depending on medium and installation.**

**We recommend to calibrate the number of pulses per litre in line with the complete installation.**