

DATA SHEET

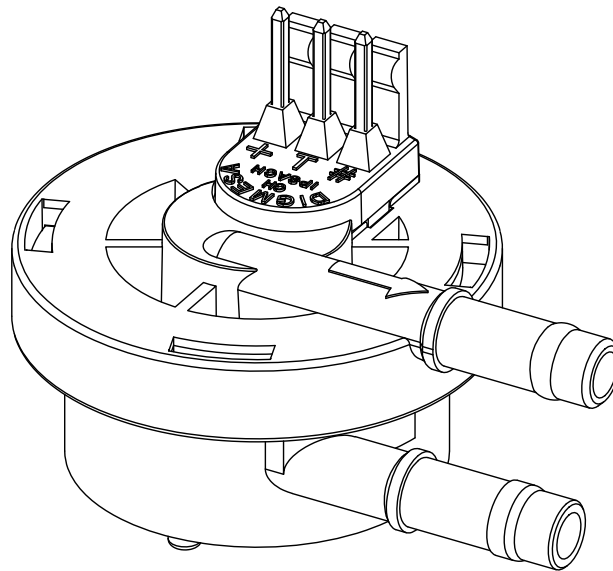

DIGimesa[®]
CHOOSE THE ORIGINAL

FHKSC PVDF using fastening pin
with double isolation
Part number: 932-930x-Vxxxx

Digimesa AG, Keltenstrasse 31, CH-2563 Ipsach / Switzerland
Phone +41 (32) 332 77 77, Fax +41 (32) 332 77 88

www.digimesa.com

Version 02 FHKSC 932-930x-Vxxxx GB Page 1-16

General Description

The FHKSC Flowmeter is a general-purpose device. The device is installed between the tank container and the vibratory pump (on the suction side) and in this way prevents the measuring errors that arise during pulsating flow caused by vibratory pumps.

Specific applications: Thanks to its closure system, the water outlet side can be assembled in four different positions. Central sprayed fastening pin \varnothing 2.8mm x 7.5mm. Recommended washer

disk: Quicklock® Benzing \varnothing 3mm or Starlock P-6490 \varnothing 3mm.

Employed in the semiconductor (wafer polishing) sector due to the high purity of materials used. Doubled isolation (liquid / electronics).

Approvals / Standards

EN55014-1:00+A1:01+A2:02, EN61000-6-3:01+A11:04, IEC61000-6-3:06(ed.2.0), EN61000-3-2:06, IEC61000-3-2:05(ed.3.0), EN61000-3-3:95+A1:01+A2:05, IEC61000-3-3:94+A1:01+A2:05(Cons.ed 1.2), EN55014-2:97+A1:01, EN61000-6-1:01, IEC61000-6-1:05(ed.2)



Material:

Housing:	PVDF
Bearing pin:	Injection-moulded like the housing
Nozzle:	Injection-moulded like the housing
O-ring:	FPM (Viton)
Turbine:	PVDF
Magnets:	2 or 4 magnets (not in contact with the medium)

Technical data:

Flow rate:	0.033 - 2 l/min depending on the nozzle diameter
Continuous operation:	< 500 rpm of the turbine
Measuring accuracy:	+/- 2.0% *
Repetition:	< +/- 0.25%
Temperature range:	-10°C to +65°C 14°F to 149°F
Pressure range:	-1 bar to 0.3 bar at 20°C -14.5 psi to 4.35 psi /68°F
Mounting position:	Horizontal *
Nozzle size:	\varnothing 1.0, 1.2, 2.0 mm

* Accuracy in the linear range for individually calibrated equipment

Electrical connection ratings:

Power supply:	+ 3.8 to + 24 VDC
Consumption:	< 8 mA
Signal connection:	Open collector NPN
Signal voltage:	0 VDC GND (saturation < 0.7 V)
Signal load:	max. 20 mA
Leakage current:	max. 10 μ A
Connections:	PANCON MAS-CON 156 MLSS
Signal:	Square-wave output
Duty Cycle:	~ 50%

Dimensions in mm:

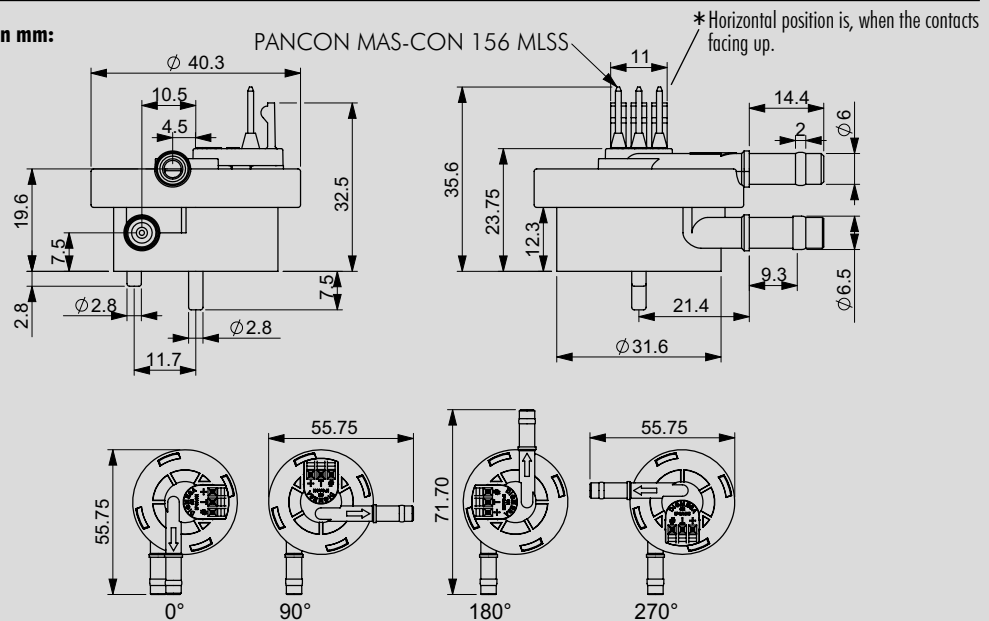

RESISTANCE

Special regulations which must be complied with by the flowmeter manufacturer apply to each country, e.g. CE, NSF, FDA and SK. The various media flowing through the flowmeter differ from application to application. You are advised to enquire with the medium manufacturer as to whether the entire installation and the flowmeter are resistant to the medium itself (see Material)!

ELECTRONIC

DIGMESA electronic circuitry is always designed for operation with DIGMESA flowmeters. Please note the following if connecting to other electronic circuitry:

- The flowmeter does not supply an output voltage but switches the signal terminal to 0 V ground (actuated) or leaves it open (non-actuated)
- There must be a pull-up resistor between power supply + and signal depending on electronic circuitry!

Interface Connection: Examples Open Collector

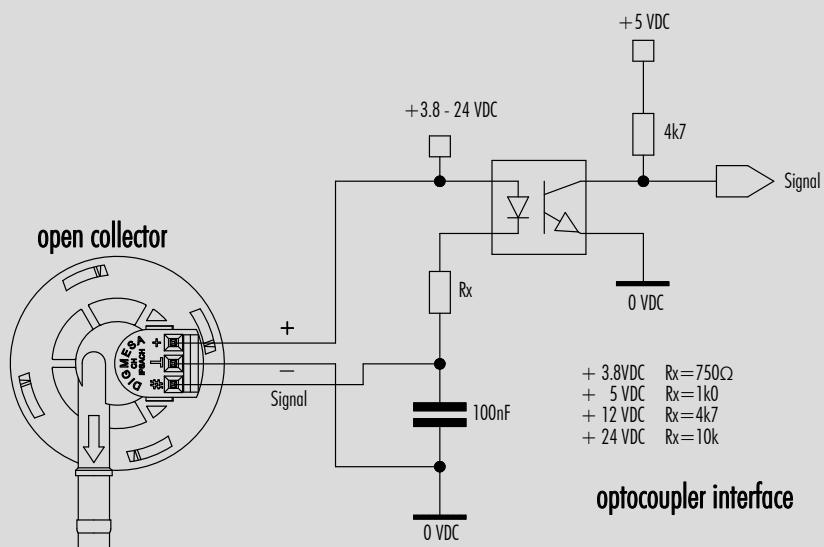
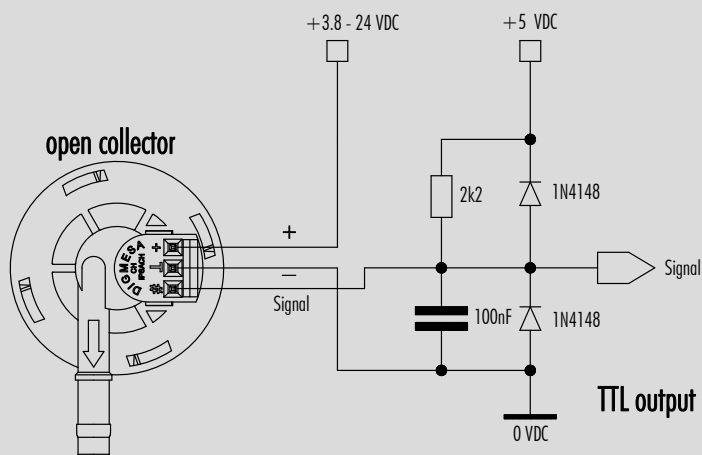
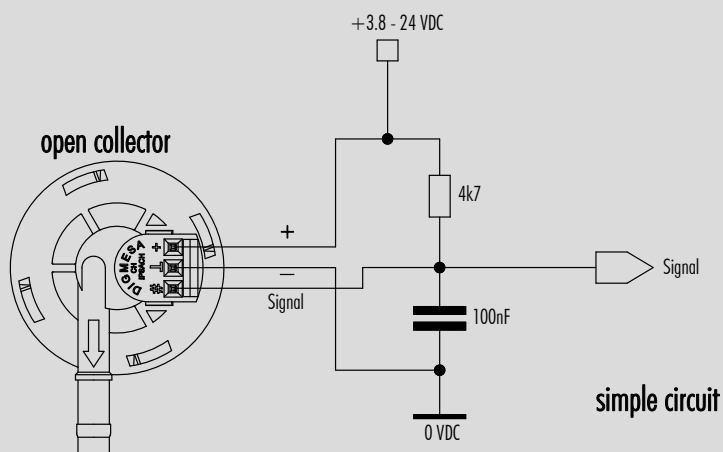

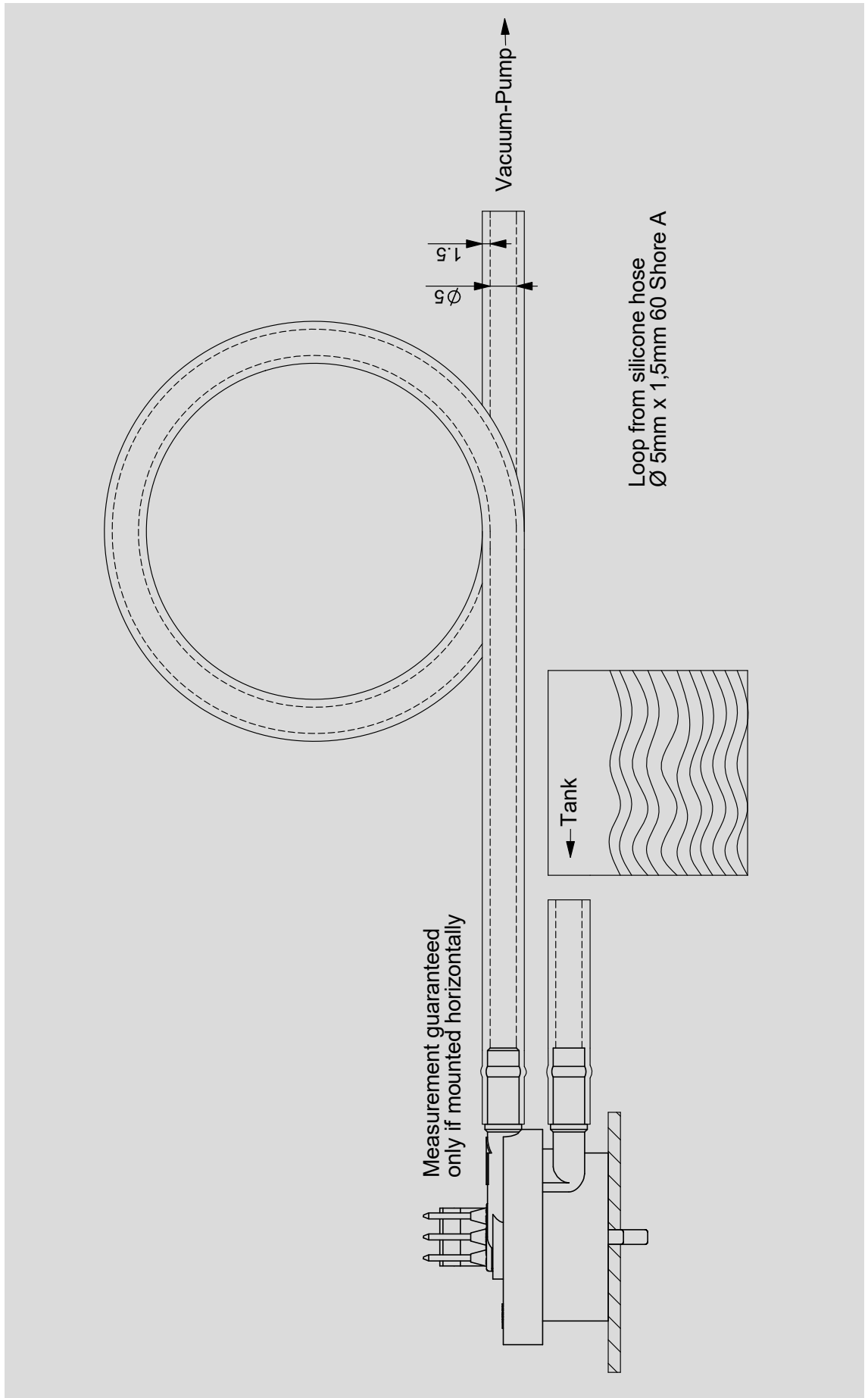

Measurement Curve FHKSC 1.00 mm 0°

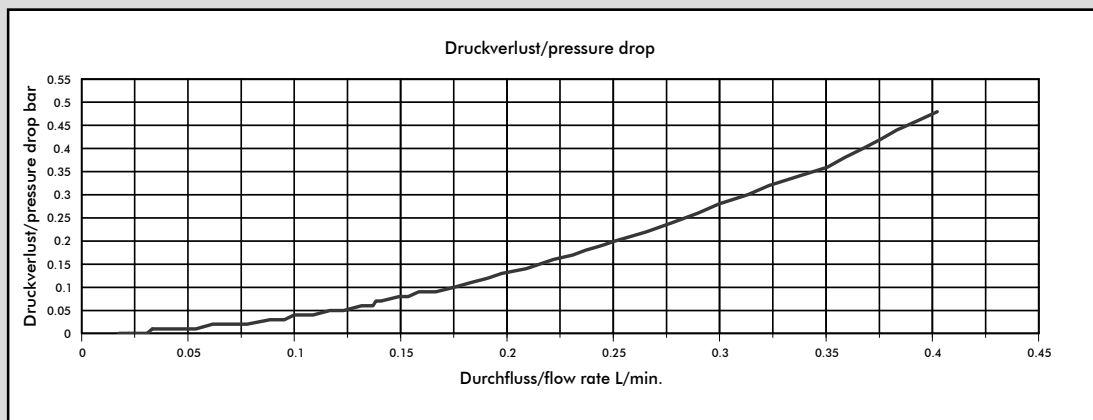
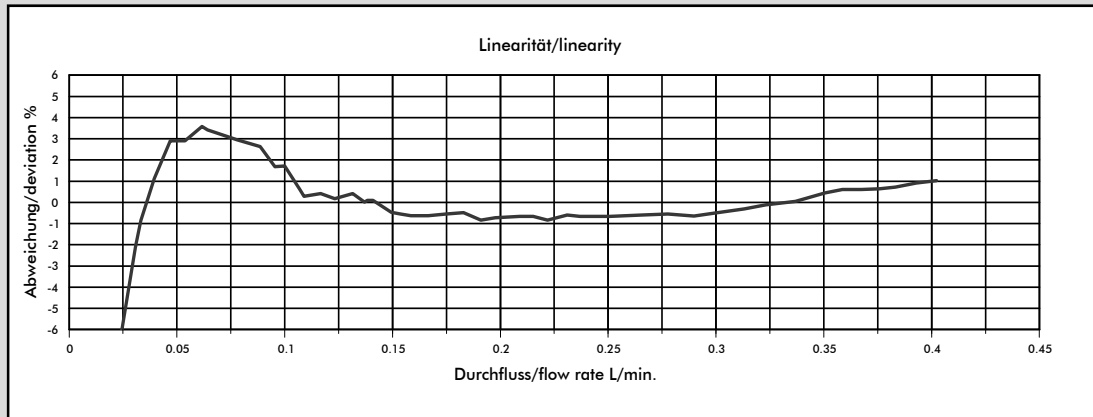

Medium: Water / max. Pressure: 1 bar (Arnite Daten)

#932-9305-V2 (2 Magnets Turbine)

Nozzle size	Pulses/litre	g/pulse	min. flow rate in litres/min at Linear start	max. flow rate in litres/min	Pressure loss
Ø 1.00 mm	2382	0.41	0.03	0.40	0.48
Ø 1.20 mm	1925	0.51	0.07	0.56	0.42
Ø 2.00 mm	1250	0.80	0.11	0.90	0.21

#932-9305-V4 (4 Magnets Turbine)

Nozzle size	Pulses/litre	g/pulse	min. flow rate in litres/min at Linear start	max. flow rate in litres/min	Pressure loss
Ø 1.00 mm	4764	0.20	0.03	0.40	0.48
Ø 1.20 mm	3850	0.25	0.07	0.56	0.42
Ø 2.00 mm	2500	0.40	0.11	0.90	0.21

The values specified must be considered as approximate values.

The number of pulses per litre may differ depending on medium and installation.

We recommend to calibrate the number of pulses per litre in line with the complete installation.

We reserve the right to make modifications in the interests of technical progress.

Version 02 FHKSC 932-930x-Vxxx GB Page 5-16

MEASUREMENT TIPS

- Ensure that there is no fast-pulsatory movement of the media
- Ensure that there are no reverse pressure surges
- Ensure that there is no air in the system
- Keep the pressure loss as small as possible
- Note the mounting position of the flowmeter
- Min/max flow should be in the linear range of the selected flowmeter
- Clean the system at appropriate intervals
- Avoid electrical current peaks
- Incorrect cabling of power supply +, signal and ground will destroy the flowmeter
- Do not mechanically load electrical contacts
- Avoid moisture on the electrical contacts
- Avoid stray pick-up via the cable (Do not lay cables in parallel with high current loads)

Measurement Curve FHKSC 1.00 mm 90°

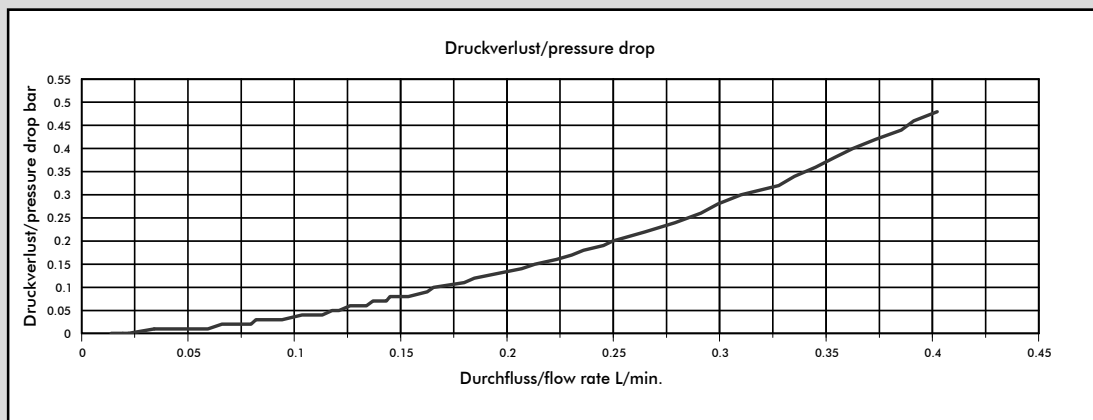
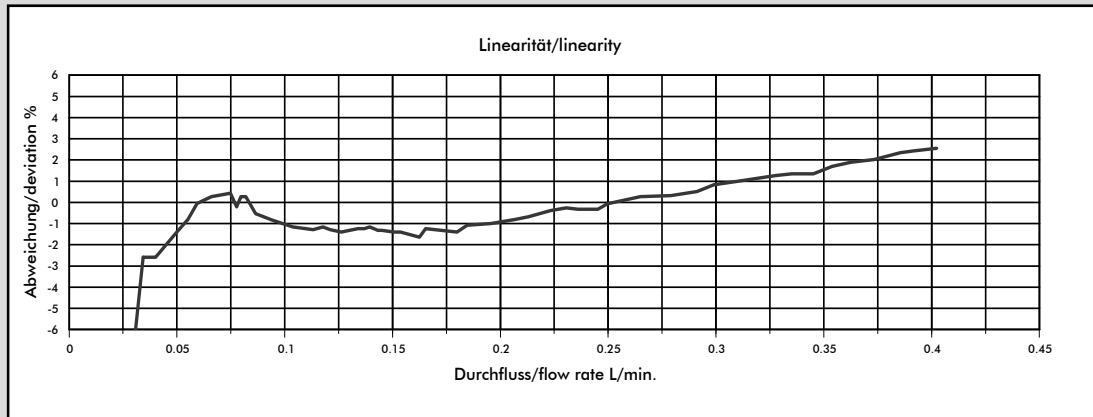

Medium: Water / max. Pressure: 1 bar (Arnite Daten)

#932-9305-V902 (2 Magnets Turbine)

Nozzle size	Pulses/litre	g/pulse	min. flow rate in litres/min at Linear start	max. flow rate in litres/min	Pressure loss
Ø 1.00 mm	2386	0.41	0.05	0.40	0.48
Ø 1.20 mm	1934	0.51	0.08	0.56	0.43
Ø 2.00 mm	1215	0.82	0.13	0.91	0.21

#932-9305-V904 (4 Magnets Turbine)

Nozzle size	Pulses/litre	g/pulse	min. flow rate in litres/min at Linear start	max. flow rate in litres/min	Pressure loss
Ø 1.00 mm	4772	0.20	0.05	0.40	0.48
Ø 1.20 mm	3868	0.25	0.08	0.56	0.43
Ø 2.00 mm	2430	0.41	0.13	0.91	0.21

The values specified must be considered as approximate values.

The number of pulses per litre may differ depending on medium and installation.

We recommend to calibrate the number of pulses per litre in line with the complete installation.

MEASUREMENT TIPS

- Ensure that there is no fast-pulsatory movement of the media
- Ensure that there are no reverse pressure surges
- Ensure that there is no air in the system
- Keep the pressure loss as small as possible
- Note the mounting position of the flowmeter
- Min/max flow should be in the linear range of the selected flowmeter
- Clean the system at appropriate intervals
- Avoid electrical current peaks
- Incorrect cabling of power supply +, signal and ground will destroy the flowmeter
- Do not mechanically load electrical contacts
- Avoid moisture on the electrical contacts
- Avoid stray pick-up via the cable (Do not lay cables in parallel with high current loads)

Measurement Curve FHKSC 1.00 mm 180°

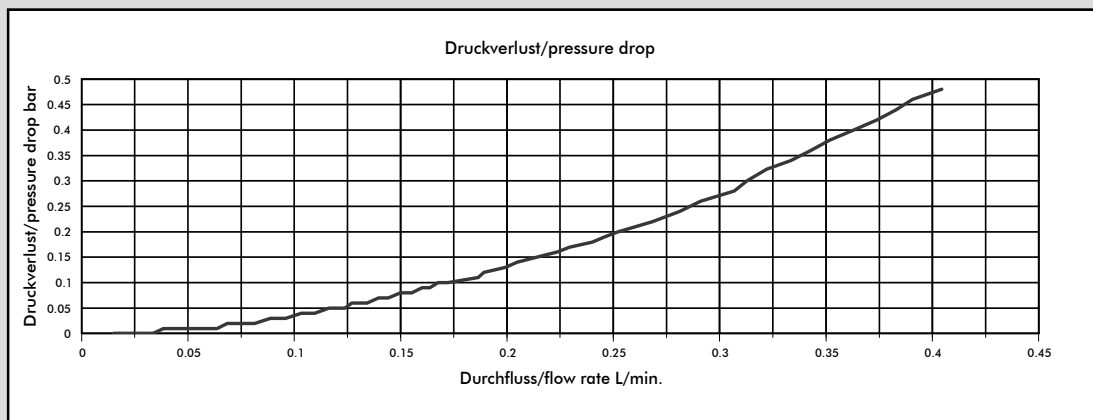
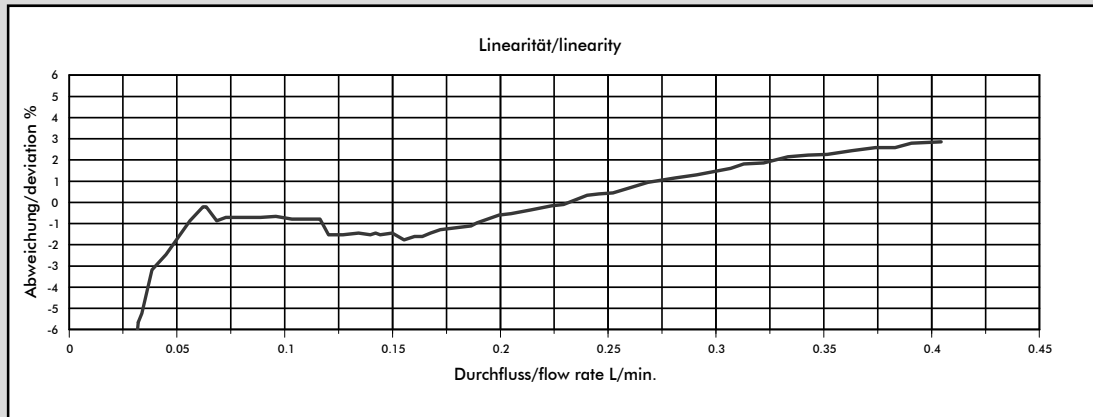

Medium: Water / max. Pressure: 1 bar (Arnite Daten)

#932-9305-V1802 (2 Magnets Turbine)

Nozzle size	Pulses/litre	g/pulse	min. flow rate in litres/min at Linear start	max. flow rate in litres/min	Pressure loss
Ø 1.00 mm	2476	0.40	0.05	0.40	0.48
Ø 1.20 mm	2016	0.49	0.10	0.57	0.43
Ø 2.00 mm	1280	0.78	0.17	0.91	0.22

#932-9305-V1804 (4 Magnets Turbine)

Nozzle size	Pulses/litre	g/pulse	min. flow rate in litres/min at Linear start	max. flow rate in litres/min	Pressure loss
Ø 1.00 mm	4952	0.20	0.05	0.40	0.48
Ø 1.20 mm	4032	0.24	0.10	0.57	0.43
Ø 2.00 mm	2560	0.39	0.17	0.91	0.22

The values specified must be considered as approximate values.

The number of pulses per litre may differ depending on medium and installation.

We recommend to calibrate the number of pulses per litre in line with the complete installation.

MEASUREMENT TIPS

- Ensure that there is no fast-pulsatory movement of the media
- Ensure that there are no reverse pressure surges
- Ensure that there is no air in the system
- Keep the pressure loss as small as possible
- Note the mounting position of the flowmeter
- Min/max flow should be in the linear range of the selected flowmeter
- Clean the system at appropriate intervals
- Avoid electrical current peaks
- Incorrect cabling of power supply +, signal and ground will destroy the flowmeter
- Do not mechanically load electrical contacts
- Avoid moisture on the electrical contacts
- Avoid stray pick-up via the cable (Do not lay cables in parallel with high current loads)

Measurement Curve FHKSC 1.00 mm 270°

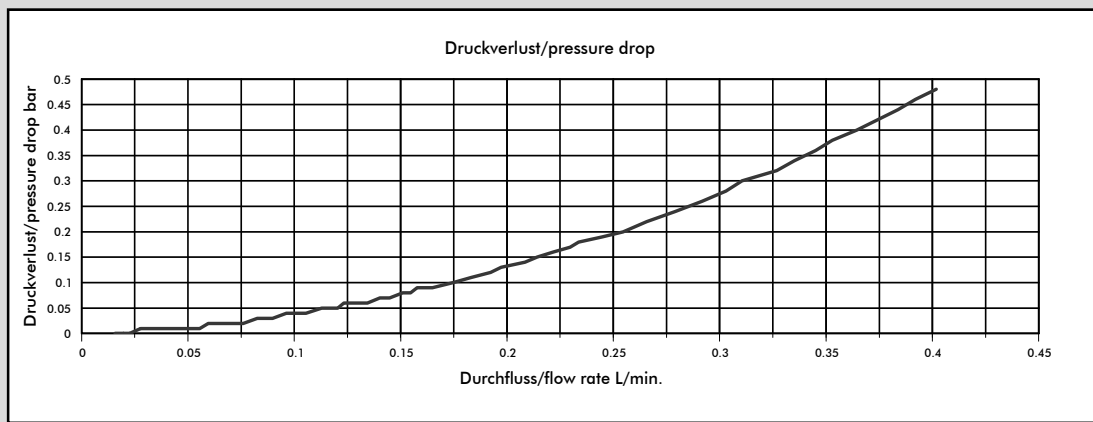
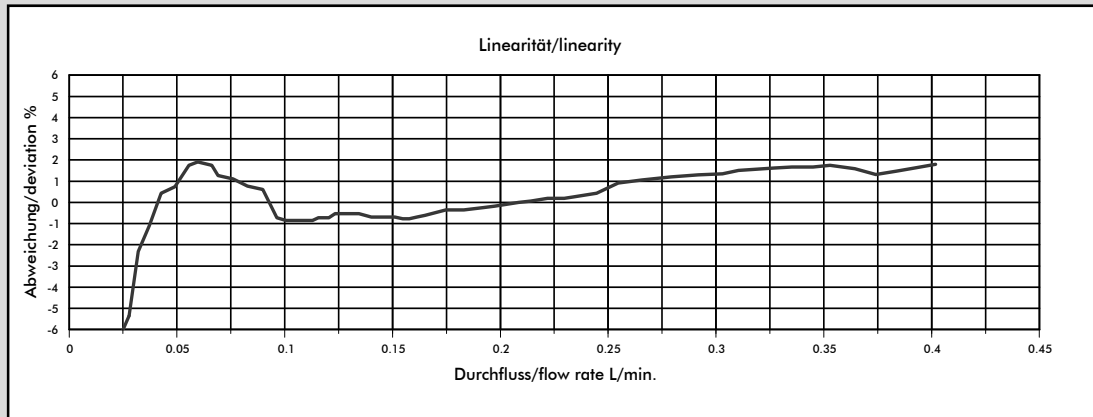

Medium: Water / max. Pressure: 1 bar (Arnite Daten)

#932-9305-V2702 (2 Magnets Turbine)

Nozzle size	Pulses/litre	g/pulse	min. flow rate in litres/min at Linear start	max. flow rate in litres/min	Pressure loss
Ø 1.00 mm	2436	0.41	0.04	0.40	0.48
Ø 1.20 mm	2012	0.49	0.08	0.56	0.42
Ø 2.00 mm	1274	0.78	0.15	0.90	0.22

#932-9305-V2704 (4 Magnets Turbine)

Nozzle size	Pulses/litre	g/pulse	min. flow rate in litres/min at Linear start	max. flow rate in litres/min	Pressure loss
Ø 1.00 mm	4872	0.20	0.04	0.40	0.48
Ø 1.20 mm	4024	0.24	0.08	0.56	0.42
Ø 2.00 mm	2548	0.39	0.15	0.90	0.22

The values specified must be considered as approximate values.

The number of pulses per litre may differ depending on medium and installation.

We recommend to calibrate the number of pulses per litre in line with the complete installation.

MEASUREMENT TIPS

- Ensure that there is no fast-pulsatory movement of the media
- Ensure that there are no reverse pressure surges
- Ensure that there is no air in the system
- Keep the pressure loss as small as possible
- Note the mounting position of the flowmeter
- Min/max flow should be in the linear range of the selected flowmeter
- Clean the system at appropriate intervals
- Avoid electrical current peaks
- Incorrect cabling of power supply +, signal and ground will destroy the flowmeter
- Do not mechanically load electrical contacts
- Avoid moisture on the electrical contacts
- Avoid stray pick-up via the cable (Do not lay cables in parallel with high current loads)

Measurement Curve FHKSC 1.20 mm 0°

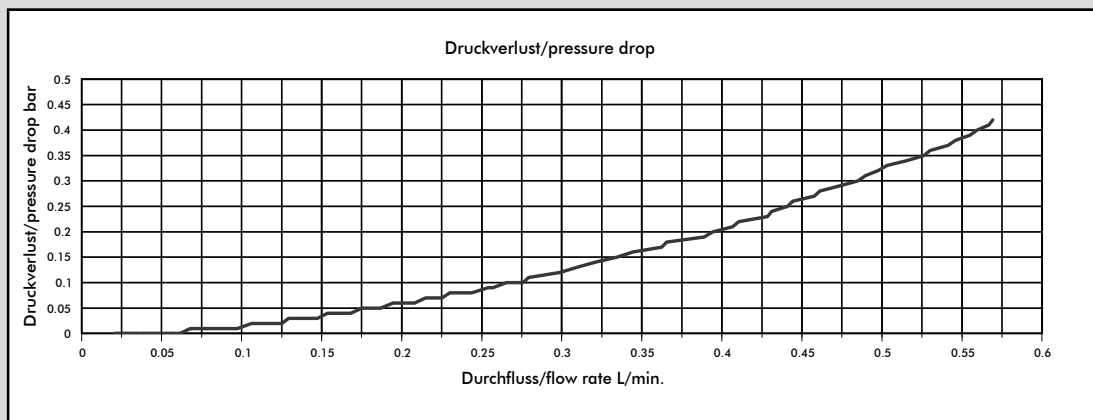
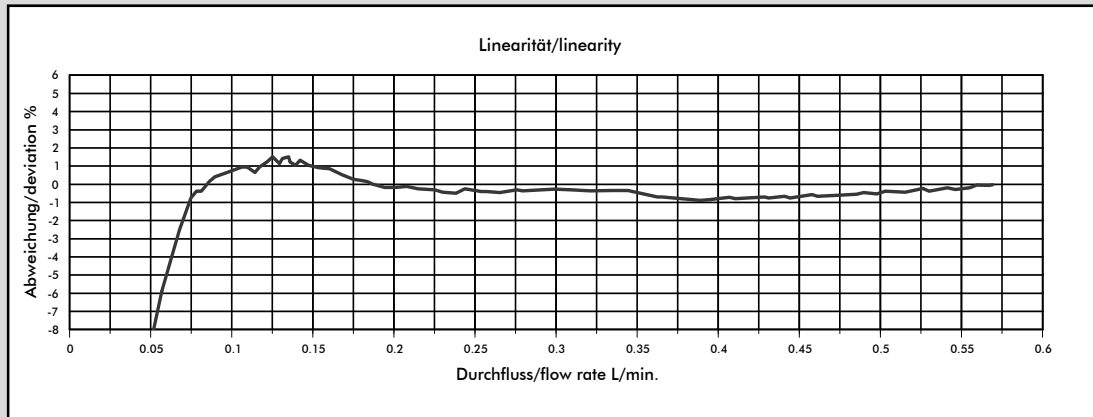

Medium: Water / max. Pressure: 1 bar (Arnite Daten)

#932-9301-V2 (2 Magnets Turbine)

Nozzle size	Pulses/litre	g/pulse	min. flow rate in litres/min at Linear start	max. flow rate in litres/min	Pressure loss
Ø 1.00 mm	2382	0.41	0.03	0.40	0.48
Ø 1.20 mm	1925	0.51	0.07	0.56	0.42
Ø 2.00 mm	1250	0.80	0.11	0.90	0.21

#932-9301-V4 (4 Magnets Turbine)

Nozzle size	Pulses/litre	g/pulse	min. flow rate in litres/min at Linear start	max. flow rate in litres/min	Pressure loss
Ø 1.00 mm	4764	0.20	0.03	0.40	0.48
Ø 1.20 mm	3850	0.25	0.07	0.56	0.42
Ø 2.00 mm	2500	0.40	0.11	0.90	0.21

The values specified must be considered as approximate values.

The number of pulses per litre may differ depending on medium and installation.

We recommend to calibrate the number of pulses per litre in line with the complete installation.

MEASUREMENT TIPS

- Ensure that there is no fast-pulsatory movement of the media
- Ensure that there are no reverse pressure surges
- Ensure that there is no air in the system
- Keep the pressure loss as small as possible
- Note the mounting position of the flowmeter
- Min/max flow should be in the linear range of the selected flowmeter
- Clean the system at appropriate intervals
- Avoid electrical current peaks
- Incorrect cabling of power supply +, signal and ground will destroy the flowmeter
- Do not mechanically load electrical contacts
- Avoid moisture on the electrical contacts
- Avoid stray pick-up via the cable (Do not lay cables in parallel with high current loads)

Measurement Curve FHKSC 1.20 mm 90°

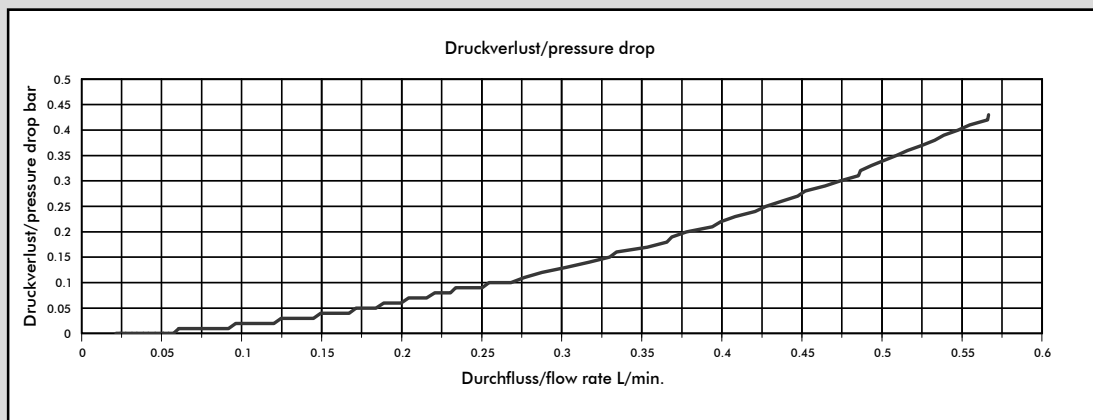
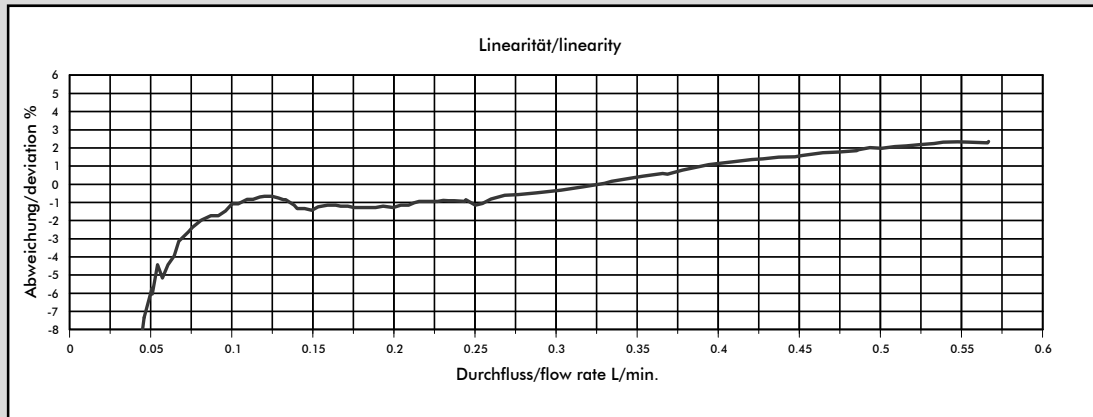

Medium: Water / max. Pressure: 1 bar (Arnite Daten)

#932-9301-V902 (2 Magnets Turbine)

Nozzle size	Pulses/litre	g/pulse	min. flow rate in litres/min at Linear start	max. flow rate in litres/min	Pressure loss
Ø 1.00 mm	2386	0.41	0.05	0.40	0.48
Ø 1.20 mm	1934	0.51	0.08	0.56	0.43
Ø 2.00 mm	1215	0.82	0.13	0.91	0.21

#932-9301-V904 (4 Magnets Turbine)

Nozzle size	Pulses/litre	g/pulse	min. flow rate in litres/min at Linear start	max. flow rate in litres/min	Pressure loss
Ø 1.00 mm	4772	0.20	0.05	0.40	0.48
Ø 1.20 mm	3868	0.25	0.08	0.56	0.43
Ø 2.00 mm	2430	0.41	0.13	0.91	0.21

The values specified must be considered as approximate values.

The number of pulses per litre may differ depending on medium and installation.

We recommend to calibrate the number of pulses per litre in line with the complete installation.

MEASUREMENT TIPS

- Ensure that there is no fast-pulsatory movement of the media
- Ensure that there are no reverse pressure surges
- Ensure that there is no air in the system
- Keep the pressure loss as small as possible
- Note the mounting position of the flowmeter
- Min/max flow should be in the linear range of the selected flowmeter
- Clean the system at appropriate intervals
- Avoid electrical current peaks
- Incorrect cabling of power supply +, signal and ground will destroy the flowmeter
- Do not mechanically load electrical contacts
- Avoid moisture on the electrical contacts
- Avoid stray pick-up via the cable (Do not lay cables in parallel with high current loads)

Measurement Curve FHKSC 1.20 mm 180°

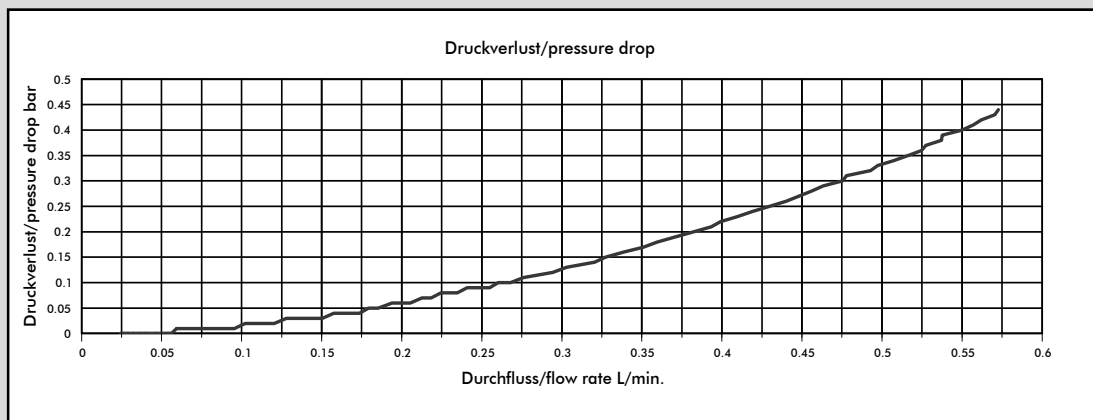
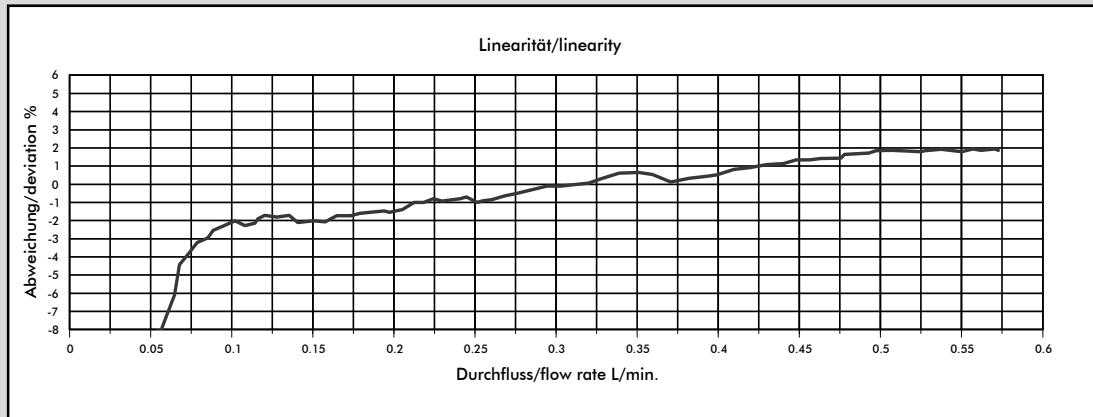

Medium: Water / max. Pressure: 1 bar (Arnite Daten)

#932-9301-V1802 (2 Magnets Turbine)

Nozzle size	Pulses/litre	g/pulse	min. flow rate in litres/min at Linear start	max. flow rate in litres/min	Pressure loss
Ø 1.00 mm	2476	0.40	0.05	0.40	0.48
Ø 1.20 mm	2016	0.49	0.10	0.57	0.43
Ø 2.00 mm	1280	0.78	0.17	0.91	0.22

#932-9301-V1804 (4 Magnets Turbine)

Nozzle size	Pulses/litre	g/pulse	min. flow rate in litres/min at Linear start	max. flow rate in litres/min	Pressure loss
Ø 1.00 mm	4952	0.20	0.05	0.40	0.48
Ø 1.20 mm	4032	0.24	0.10	0.57	0.43
Ø 2.00 mm	2560	0.39	0.17	0.91	0.22

The values specified must be considered as approximate values.

The number of pulses per litre may differ depending on medium and installation.

We recommend to calibrate the number of pulses per litre in line with the complete installation.

We reserve the right to make modifications in the interests of technical progress.

MEASUREMENT TIPS

- Ensure that there is no fast-pulsatory movement of the media
- Ensure that there are no reverse pressure surges
- Ensure that there is no air in the system
- Keep the pressure loss as small as possible
- Note the mounting position of the flowmeter
- Min/max flow should be in the linear range of the selected flowmeter
- Clean the system at appropriate intervals
- Avoid electrical current peaks
- Incorrect cabling of power supply +, signal and ground will destroy the flowmeter
- Do not mechanically load electrical contacts
- Avoid moisture on the electrical contacts
- Avoid stray pick-up via the cable (Do not lay cables in parallel with high current loads)

Version 02 FHKSC 932-930x-Vxxx GB Page 11-16

Measurement Curve FHKSC 1.20 mm 270°

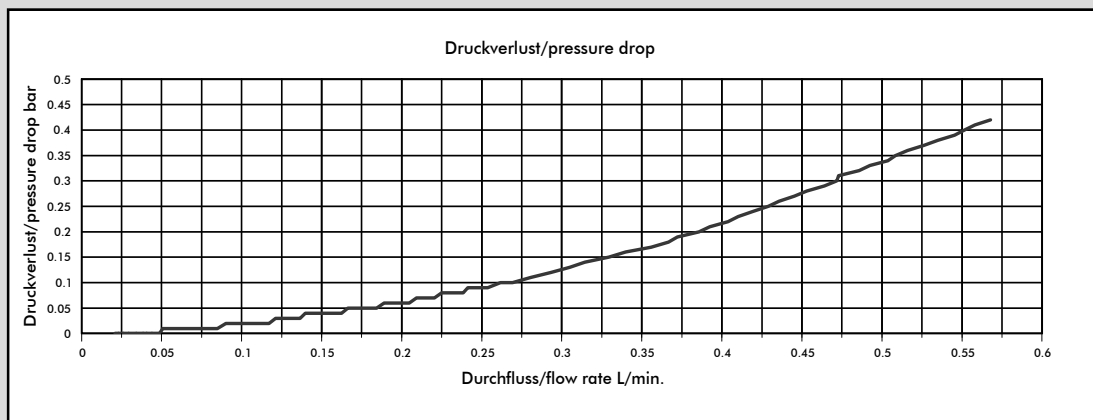
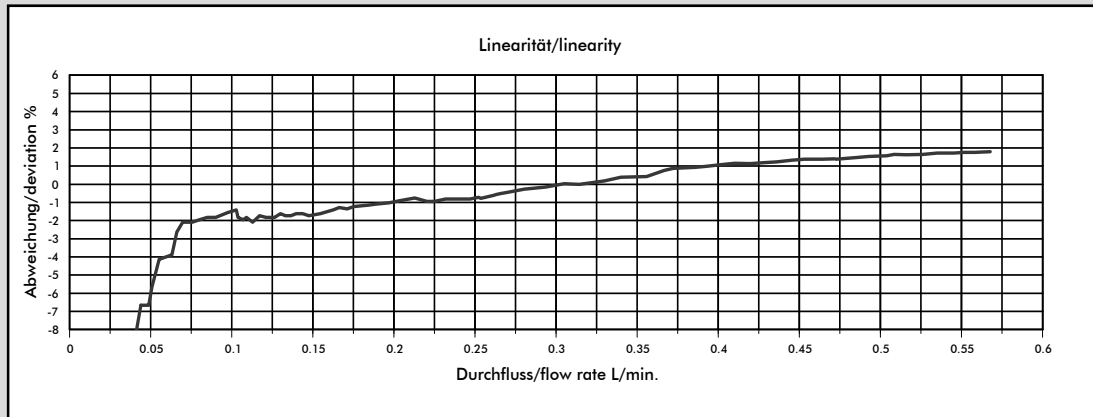

Medium: Water / max. Pressure: 1 bar (Arnite Daten)

#932-9301-V2702 (2 Magnets Turbine)

Nozzle size	Pulses/litre	g/pulse	min. flow rate in litres/min at Linear start	max. flow rate in litres/min	Pressure loss
Ø 1.00 mm	2436	0.41	0.04	0.40	0.48
Ø 1.20 mm	2012	0.49	0.08	0.56	0.42
Ø 2.00 mm	1274	0.78	0.15	0.90	0.22

#932-9301-V2704 (4 Magnets Turbine)

Nozzle size	Pulses/litre	g/pulse	min. flow rate in litres/min at Linear start	max. flow rate in litres/min	Pressure loss
Ø 1.00 mm	4872	0.20	0.04	0.40	0.48
Ø 1.20 mm	4024	0.24	0.08	0.56	0.42
Ø 2.00 mm	2548	0.39	0.15	0.90	0.22

The values specified must be considered as approximate values.

The number of pulses per litre may differ depending on medium and installation.

We recommend to calibrate the number of pulses per litre in line with the complete installation.

We reserve the right to make modifications in the interests of technical progress.

MEASUREMENT TIPS

- Ensure that there is no fast-pulsatory movement of the media
- Ensure that there are no reverse pressure surges
- Ensure that there is no air in the system
- Keep the pressure loss as small as possible
- Note the mounting position of the flowmeter
- Min/max flow should be in the linear range of the selected flowmeter
- Clean the system at appropriate intervals
- Avoid electrical current peaks
- Incorrect cabling of power supply +, signal and ground will destroy the flowmeter
- Do not mechanically load electrical contacts
- Avoid moisture on the electrical contacts
- Avoid stray pick-up via the cable (Do not lay cables in parallel with high current loads)

Version 02 FHKSC 932-930x-Vxxx GB Page 12-16

Measurement Curve FHKSC 2.00 mm 0°

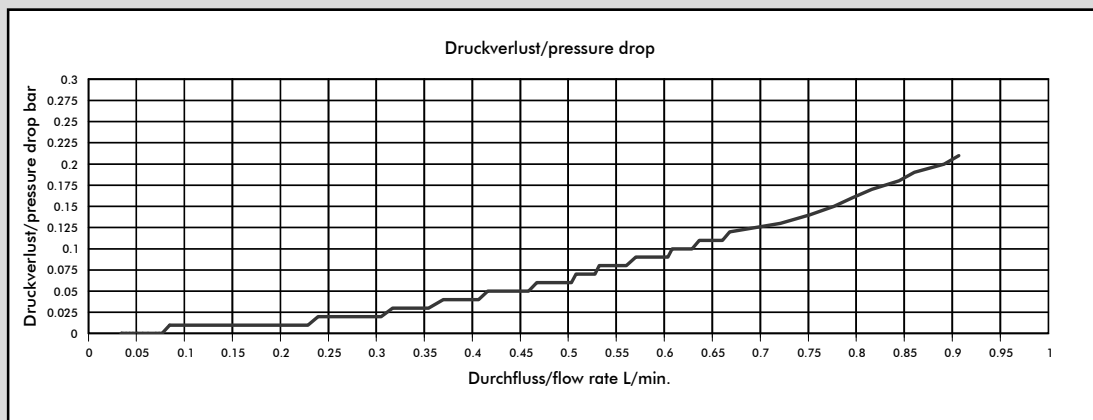
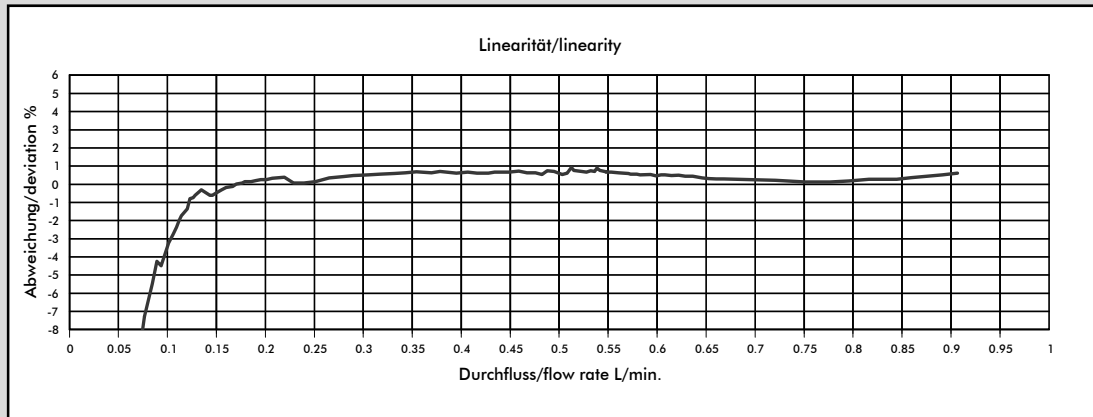

Medium: Water / max. Pressure: 1 bar (Arnite Daten)

#932-9306-V2 (2 Magnets Turbine)

Nozzle size	Pulses/litre	g/pulse	min. flow rate in litres/min at Linear start	max. flow rate in litres/min	Pressure loss
Ø 1.00 mm	2382	0.41	0.03	0.40	0.48
Ø 1.20 mm	1925	0.51	0.07	0.56	0.42
Ø 2.00 mm	1250	0.80	0.11	0.90	0.21

#932-9306-V4 (4 Magnets Turbine)

Nozzle size	Pulses/litre	g/pulse	min. flow rate in litres/min at Linear start	max. flow rate in litres/min	Pressure loss
Ø 1.00 mm	4764	0.20	0.03	0.40	0.48
Ø 1.20 mm	3850	0.25	0.07	0.56	0.42
Ø 2.00 mm	2500	0.40	0.11	0.90	0.21

The values specified must be considered as approximate values.

The number of pulses per litre may differ depending on medium and installation.

We recommend to calibrate the number of pulses per litre in line with the complete installation.

MEASUREMENT TIPS

- Ensure that there is no fast-pulsatory movement of the media
- Ensure that there are no reverse pressure surges
- Ensure that there is no air in the system
- Keep the pressure loss as small as possible
- Note the mounting position of the flowmeter
- Min/max flow should be in the linear range of the selected flowmeter
- Clean the system at appropriate intervals
- Avoid electrical current peaks
- Incorrect cabling of power supply +, signal and ground will destroy the flowmeter
- Do not mechanically load electrical contacts
- Avoid moisture on the electrical contacts
- Avoid stray pick-up via the cable (Do not lay cables in parallel with high current loads)

Measurement Curve FHKSC 2.00 mm 90°

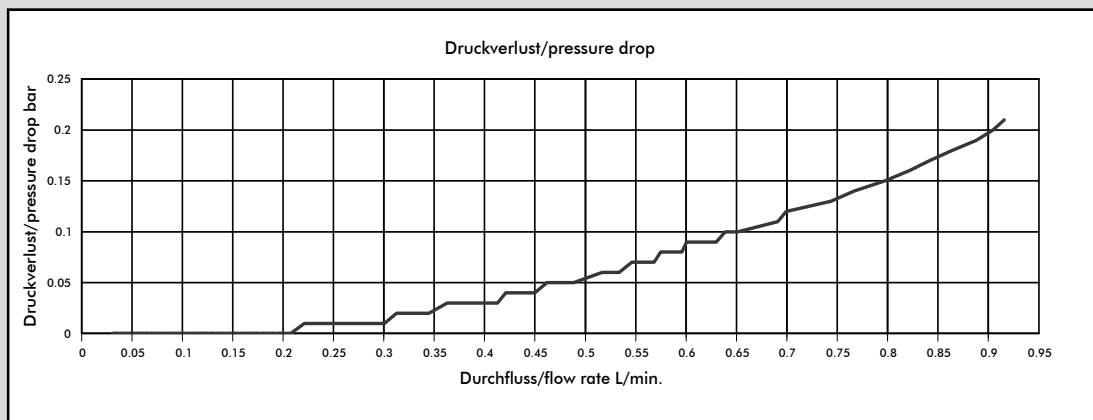
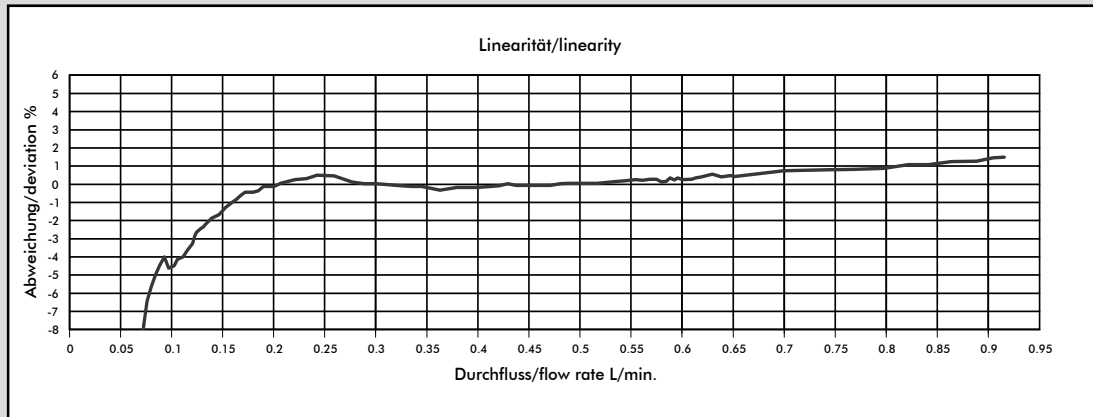

Medium: Water / max. Pressure: 1 bar (Arnite Daten)

#932-9306-V902 (2 Magnets Turbine)

Nozzle size	Pulses/litre	g/pulse	min. flow rate in litres/min at Linear start	max. flow rate in litres/min	Pressure loss
Ø 1.00 mm	2386	0.41	0.05	0.40	0.48
Ø 1.20 mm	1934	0.51	0.08	0.56	0.43
Ø 2.00 mm	1215	0.82	0.13	0.91	0.21

#932-9306-V904 (4 Magnets Turbine)

Nozzle size	Pulses/litre	g/pulse	min. flow rate in litres/min at Linear start	max. flow rate in litres/min	Pressure loss
Ø 1.00 mm	4772	0.20	0.05	0.40	0.48
Ø 1.20 mm	3868	0.25	0.08	0.56	0.43
Ø 2.00 mm	2430	0.41	0.13	0.91	0.21

The values specified must be considered as approximate values.

The number of pulses per litre may differ depending on medium and installation.

We recommend to calibrate the number of pulses per litre in line with the complete installation.

We reserve the right to make modifications in the interests of technical progress.

MEASUREMENT TIPS

- Ensure that there is no fast-pulsatory movement of the media
- Ensure that there are no reverse pressure surges
- Ensure that there is no air in the system
- Keep the pressure loss as small as possible
- Note the mounting position of the flowmeter
- Min/max flow should be in the linear range of the selected flowmeter
- Clean the system at appropriate intervals
- Avoid electrical current peaks
- Incorrect cabling of power supply +, signal and ground will destroy the flowmeter
- Do not mechanically load electrical contacts
- Avoid moisture on the electrical contacts
- Avoid stray pick-up via the cable (Do not lay cables in parallel with high current loads)

Version 02 FHKSC 932-930x-Vxxx GB Page 14-16

Measurement Curve FHKSC 2.00 mm 180°

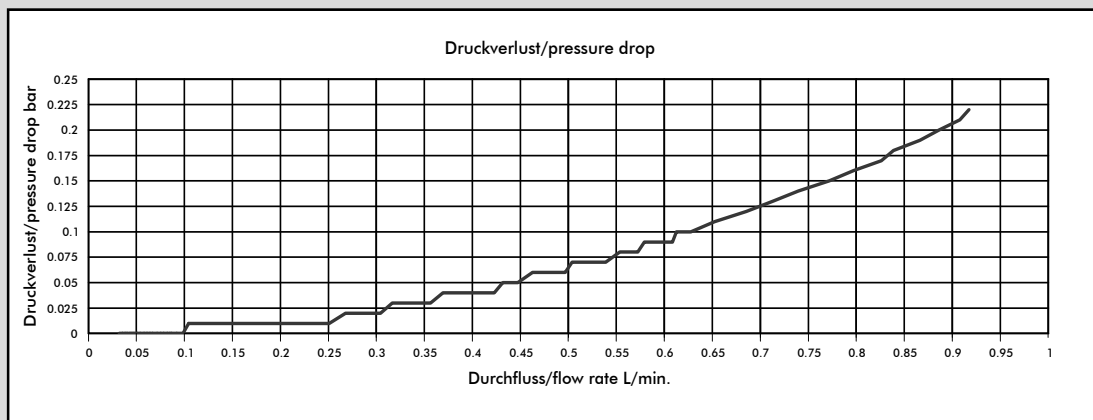
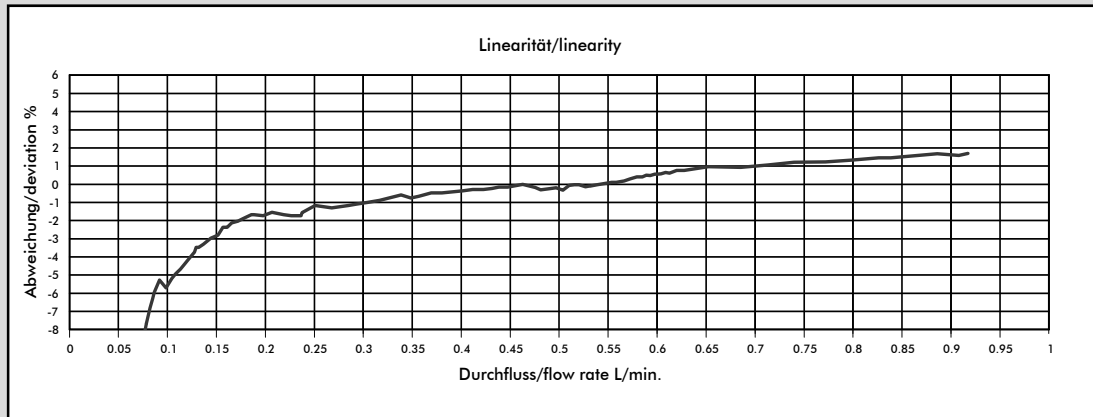

Medium: Water / max. Pressure: 1 bar (Arnite Daten)

#932-9306-V1802 (2 Magnets Turbine)

Nozzle size	Pulses/litre	g/pulse	min. flow rate in litres/min at Linear start	max. flow rate in litres/min	Pressure loss
Ø 1.00 mm	2476	0.40	0.05	0.40	0.48
Ø 1.20 mm	2016	0.49	0.10	0.57	0.43
Ø 2.00 mm	1280	0.78	0.17	0.91	0.22

#932-9306-V1804 (4 Magnets Turbine)

Nozzle size	Pulses/litre	g/pulse	min. flow rate in litres/min at Linear start	max. flow rate in litres/min	Pressure loss
Ø 1.00 mm	4952	0.20	0.05	0.40	0.48
Ø 1.20 mm	4032	0.24	0.10	0.57	0.43
Ø 2.00 mm	2560	0.39	0.17	0.91	0.22

The values specified must be considered as approximate values.

The number of pulses per litre may differ depending on medium and installation.

We recommend to calibrate the number of pulses per litre in line with the complete installation.

We reserve the right to make modifications in the interests of technical progress.

MEASUREMENT TIPS

- Ensure that there is no fast-pulsatory movement of the media
- Ensure that there are no reverse pressure surges
- Ensure that there is no air in the system
- Keep the pressure loss as small as possible
- Note the mounting position of the flowmeter
- Min/max flow should be in the linear range of the selected flowmeter
- Clean the system at appropriate intervals
- Avoid electrical current peaks
- Incorrect cabling of power supply +, signal and ground will destroy the flowmeter
- Do not mechanically load electrical contacts
- Avoid moisture on the electrical contacts
- Avoid stray pick-up via the cable (Do not lay cables in parallel with high current loads)

Version 02 FHKSC 932-930x-Vxxx GB Page 15-16

Measurement Curve FHKSC 2.00 mm 270°

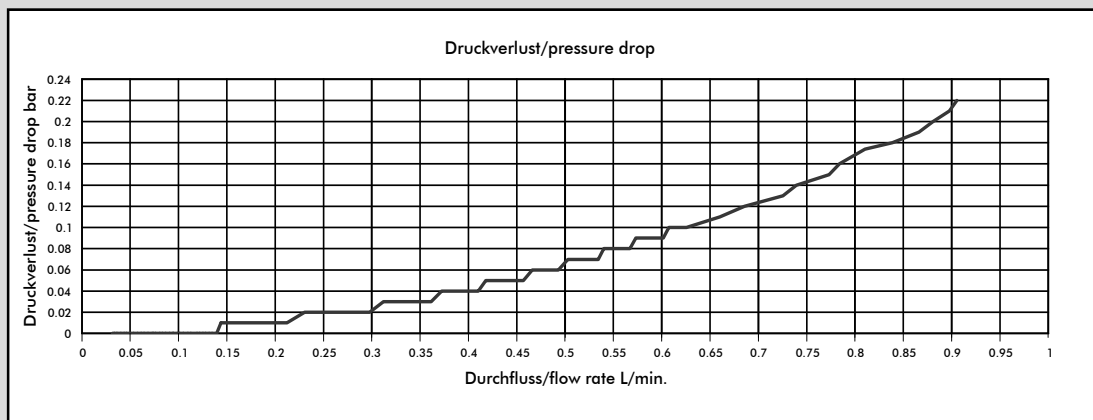
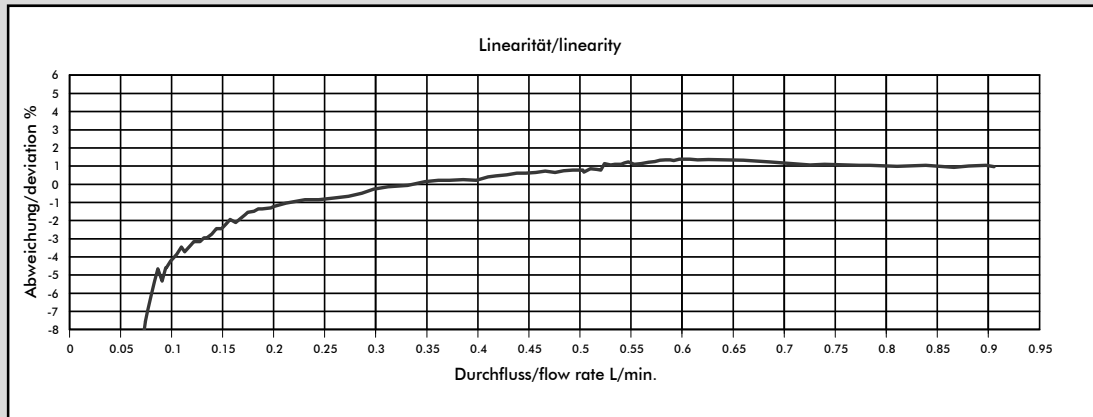

Medium: Water / max. Pressure: 1 bar (Arnite Daten)

#932-9306-V2702 (2 Magnets Turbine)

Nozzle size	Pulses/litre	g/pulse	min. flow rate in litres/min at Linear start	max. flow rate in litres/min	Pressure loss
Ø 1.00 mm	2436	0.41	0.04	0.40	0.48
Ø 1.20 mm	2012	0.49	0.08	0.56	0.42
Ø 2.00 mm	1274	0.78	0.15	0.90	0.22

#932-9306-V2704 (4 Magnets Turbine)

Nozzle size	Pulses/litre	g/pulse	min. flow rate in litres/min at Linear start	max. flow rate in litres/min	Pressure loss
Ø 1.00 mm	4872	0.20	0.04	0.40	0.48
Ø 1.20 mm	4024	0.24	0.08	0.56	0.42
Ø 2.00 mm	2548	0.39	0.15	0.90	0.22

The values specified must be considered as approximate values.

The number of pulses per litre may differ depending on medium and installation.

We recommend to calibrate the number of pulses per litre in line with the complete installation.

We reserve the right to make modifications in the interests of technical progress.

MEASUREMENT TIPS

- Ensure that there is no fast-pulsatory movement of the media
- Ensure that there are no reverse pressure surges
- Ensure that there is no air in the system
- Keep the pressure loss as small as possible
- Note the mounting position of the flowmeter
- Min/max flow should be in the linear range of the selected flowmeter
- Clean the system at appropriate intervals
- Avoid electrical current peaks
- Incorrect cabling of power supply +, signal and ground will destroy the flowmeter
- Do not mechanically load electrical contacts
- Avoid moisture on the electrical contacts
- Avoid stray pick-up via the cable (Do not lay cables in parallel with high current loads)

Version 02 FHKSC 932-930x-Vxxx GB Page 16-16