

DATA SHEET

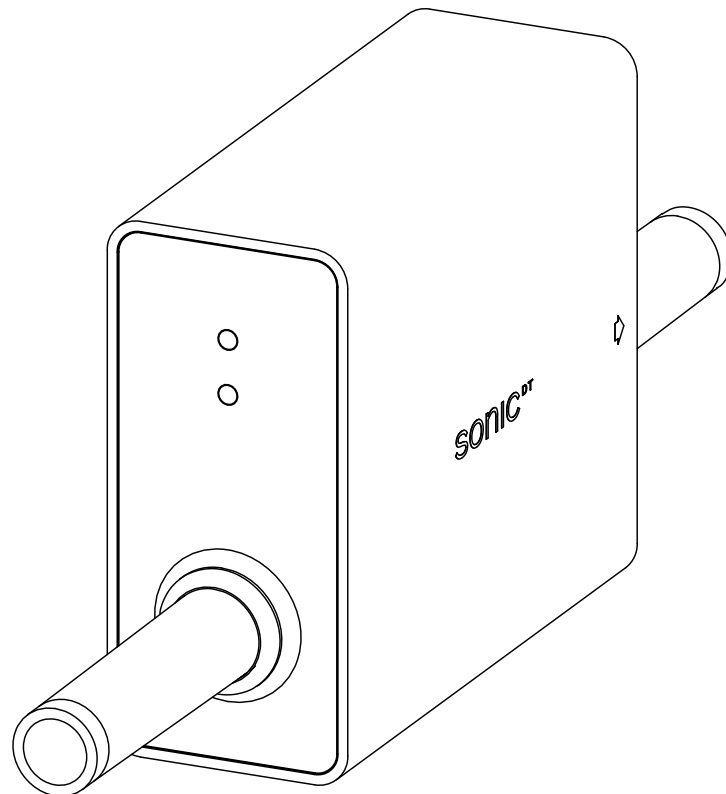

DIGimesa⁺
SWITZERLAND

sonic^{DT30}
Part number: 990-1101/03

Digimesa AG, Keltenstrasse 31, CH-2563 Ipsach / Switzerland
Phone +41 (32) 332 77 77, Fax +41 (32) 332 77 88

www.digimesa.com

Version 02 SONIC DT30 #990-1101/03 GB Page 1-5

General Description

The sonic^{DT30} flow sensor features a huge dynamic range as well as excellent accuracy for a lot of different liquids. Additionally to the pulse and 4-20mA current output, a RS-485 port (MODBUS-protocol) and 2 configurable outputs, that allow dosing and flow rate alarms without the need of external electronics, are included.

The configuration of the flow sensor is set with standard MODBUS functions. The device is also more than adequate for the demanding requirements of the semiconductor industry. The Flarecompatible 1/2" connectors guarantee a safe and simple installation.

Special features: Compact housing with integral electronics. With no moving parts, the device is wear and maintenance-free. RS-485 interface (MODBUS-protocol). 2 configurable outputs (dosing and flow rate alarms).



Materials:

Wetted parts: PFA (tube)
 Weight: ~ 400 gram
 Housing: PP with FKM seal protection class of IPx5
 Screw nut: M3 x 6mm deep (PP 20% GF)
 Cable: Teflon

Technical data:

Measuring fluid: water based liquids (for other liquids contact Digmesa)
 Calibration fluid: water 25°C
 Linear range: 0.1 - 20.0 l/min (zero flow cutoff at 100ml/min)
 Response time: ~ 150ms
 Measuring accuracy: ± 50ml/min or ± 2.0% of reading
 Fluid measurement temperature: + 10°C to + 30°C 50°F to 86°F
 Pressure range: 10 bar at 20°C 145 psi /68°F
 Mounting position: freely selectable
 Nozzle size: Ø 9.60mm
 Fittings: 1/2" flare compatible

Electrical connection:

Power supply: + 12VDC to + 24VDC
 Consumption: max. 240mA (@12VDC)
 Pulse output: Open collector NPN, 1000 pulses per litre (max. 30VDC, 30mA)
 Current output: 4 - 20mA
 Digital I/O: 2 conf. outputs open collector NPN (max. 30VDC, 30mA)
 Serial port: RS-485 (Modbus-protocol)
 Status LED: Green = normal operation Red = sensor disfunction Orange = warning (no fluid, bubbles, particles, etc.)
 Connections: Cable 12 x AWG 22/7 (open wire) cable length on request, max. 5.0 meter (standard 1.5 meter)

Configurable Outputs

Dosing mode	Output is HIGH until volume is reached
Flow alarm >	Output is HIGH as soon as flow rate > alarm value
Flow alarm <	Output is HIGH as soon as flow rate < alarm value
Volume alarm	Output is HIGH as soon as volume is reached
Trigger source:	INPUT 1 (rising edge) INPUT 2 (rising edge) MODBUS RS-485 ALWAYS ON

CABLE PINOUT

Kabel Nr.	Beschreibung
1	RS-485A
2	RS-485B
3	GND
4	GND
5	Power supply + 12 VDC bis + 24 VDC
6	Volumetric Pulse Output
7	4 - 20mA current output
8	Configurable Output 1
9	Configurable Output 2
10	Configurable Input 1
11	Configurable Input 2
12	GND (for Inputs and Outputs, wire 8 - 11)

We reserve the right to make modifications in the interests of technical progress.

RESISTANCE

Special regulations which must be complied with by the flow sensor manufacturer apply to each country, e.g. CE, NSF, FDA and SK. The various media flowing through the flow sensor differ from application to application. You are advised to enquire with the medium manufacturer as to whether the entire installation and the flow sensor are resistant to the medium itself (see Material)!

ELECTRONIC

DIGMESA electronic circuitry is always designed for operation with DIGMESA flow sensors. Please note the following if connecting to other electronic circuitry:

- The flow sensor does not supply an output voltage but switches the signal terminal to 0 V ground (actuated) or leaves it open (non-actuated)
- There must be a pull-up resistor between power supply + and signal depending on electronic circuitry!

Version 02 SONIC DT30 #990-1101/03 GB Page 2-5

Dimensions in mm

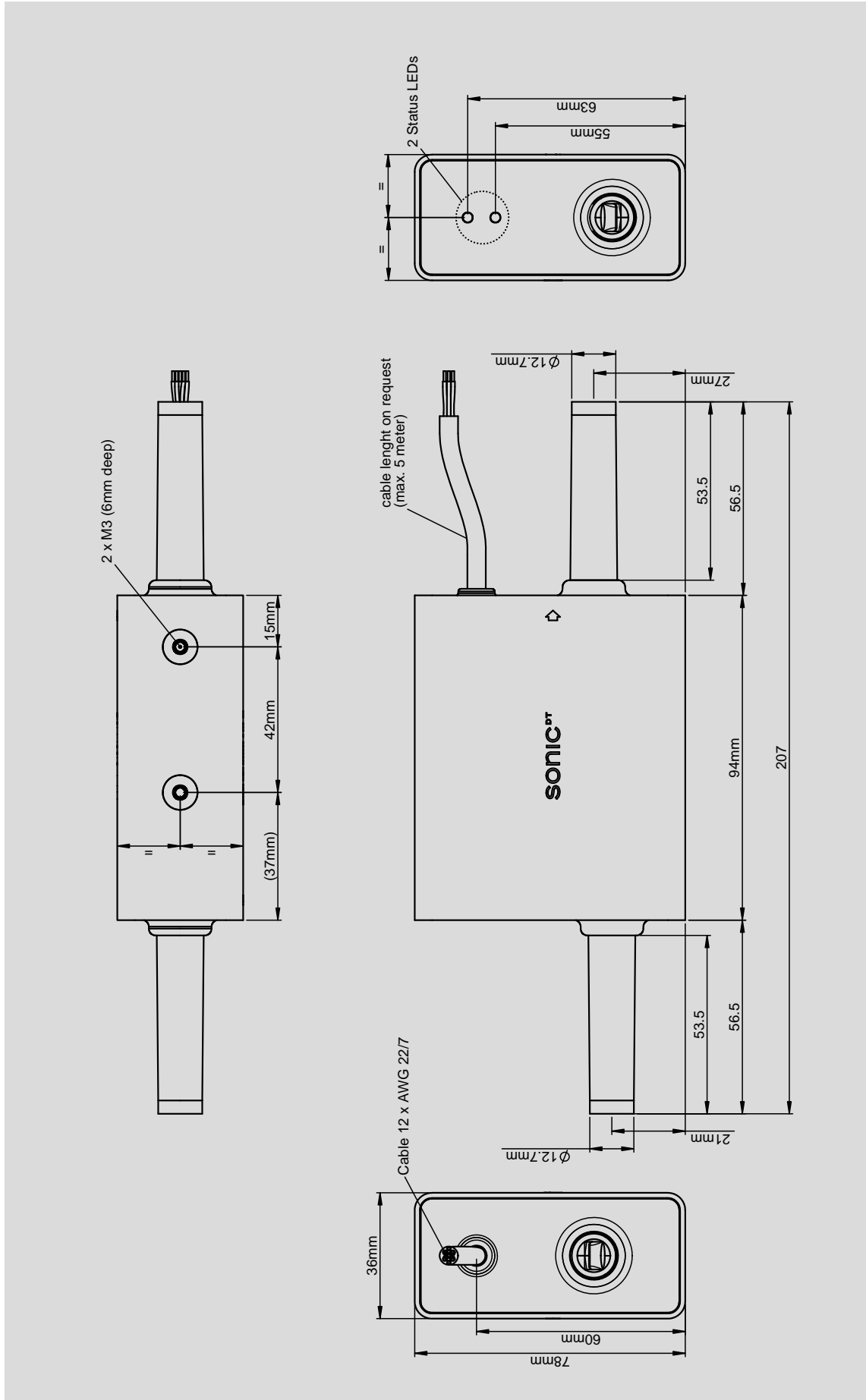

We reserve the right to make modifications in the interests of technical progress.

Version 02 SONIC DT30 #990-1101/03 GB Page 3-5

Interface Connection: Examples Open Collector

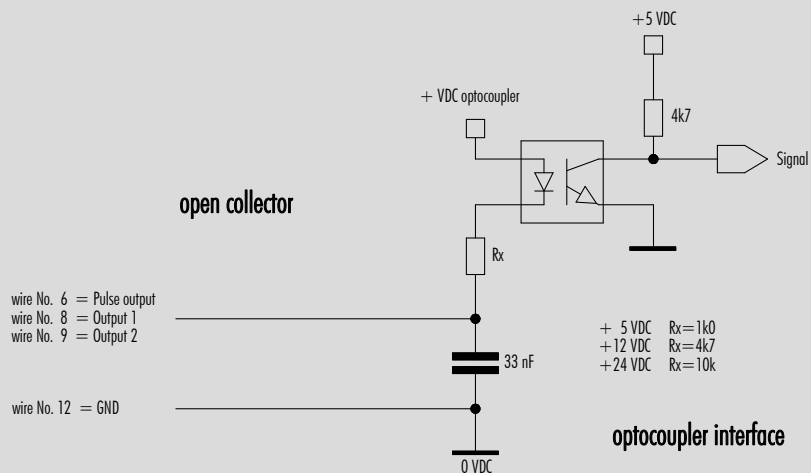
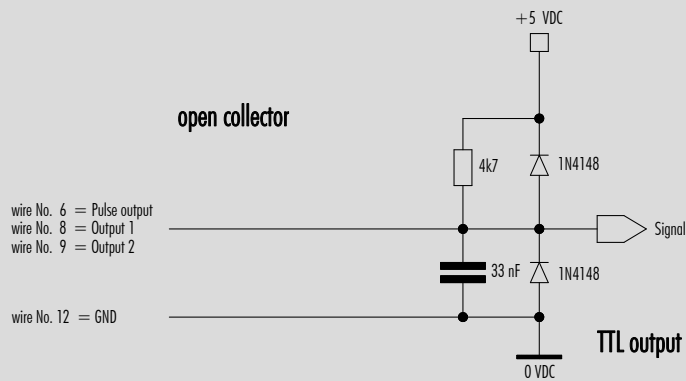
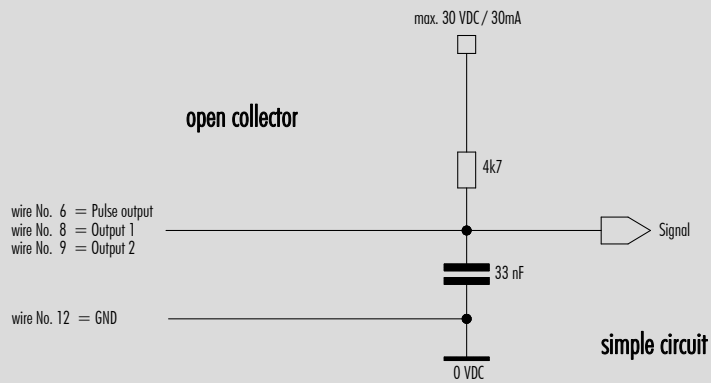

Measurement sonic^{DT30}

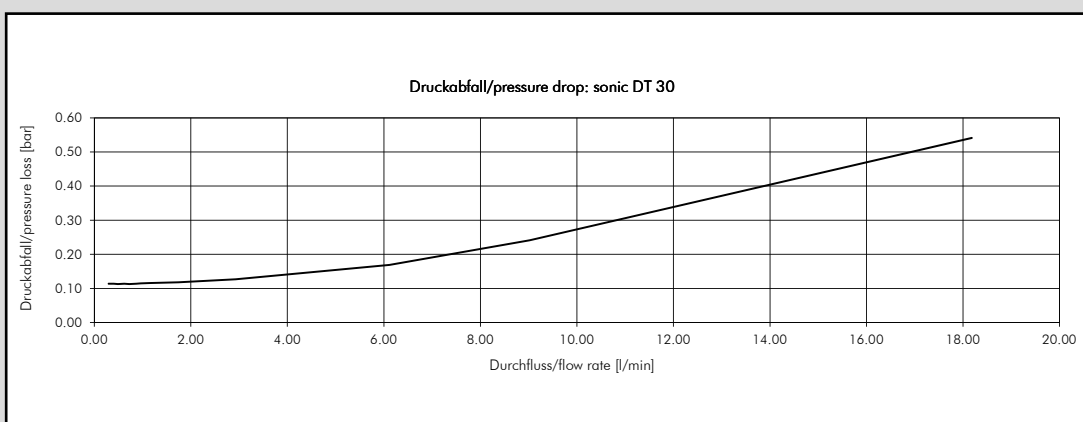
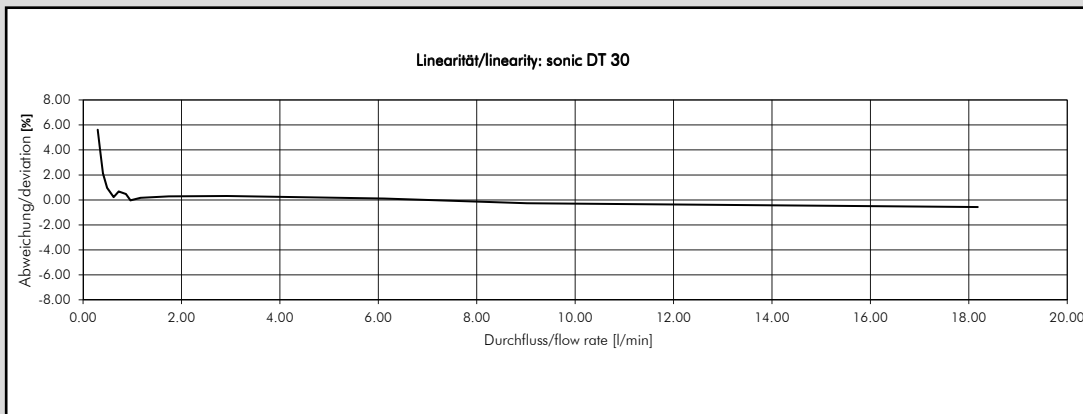

Fluid: Water / 25°C

Factory Settings	
Puls rate ¹⁾	1000 imp/l (Q 0.1 - 12 l/min)
Current output ²⁾	20mA @ 12 l/min
Cutoff	100 ml
Configurable outputs	OFF
¹⁾ Puls rate (adjustable)	500 imp/l (Q 0.1 - 20 l/min)
²⁾ Current output (adjustable)	0 l/min flow rate = 4mA max. flow rate = 20mA

The number of pulses per litre may differ depending on medium and installation. We recommend to calibrate the number of pulses per litre in line with the complete installation.

MEASUREMENT TIPS

- Ensure that there is no fast-pulsatory movement of the fluid
- Ensure that there are no reverse pressure surges
- Ensure that there is no air in the system
- Keep the pressure loss as small as possible
- Min/max flow should be in the linear range of the selected flow sensor
- Clean the system at appropriate intervals
- Avoid electrical voltage spikes
- Incorrect wiring may destroy the flow sensor
- Avoid stray pick-up via the cable (Do not lay cables in parallel with high current loads)