

Operating Instructions

FHK-LCD

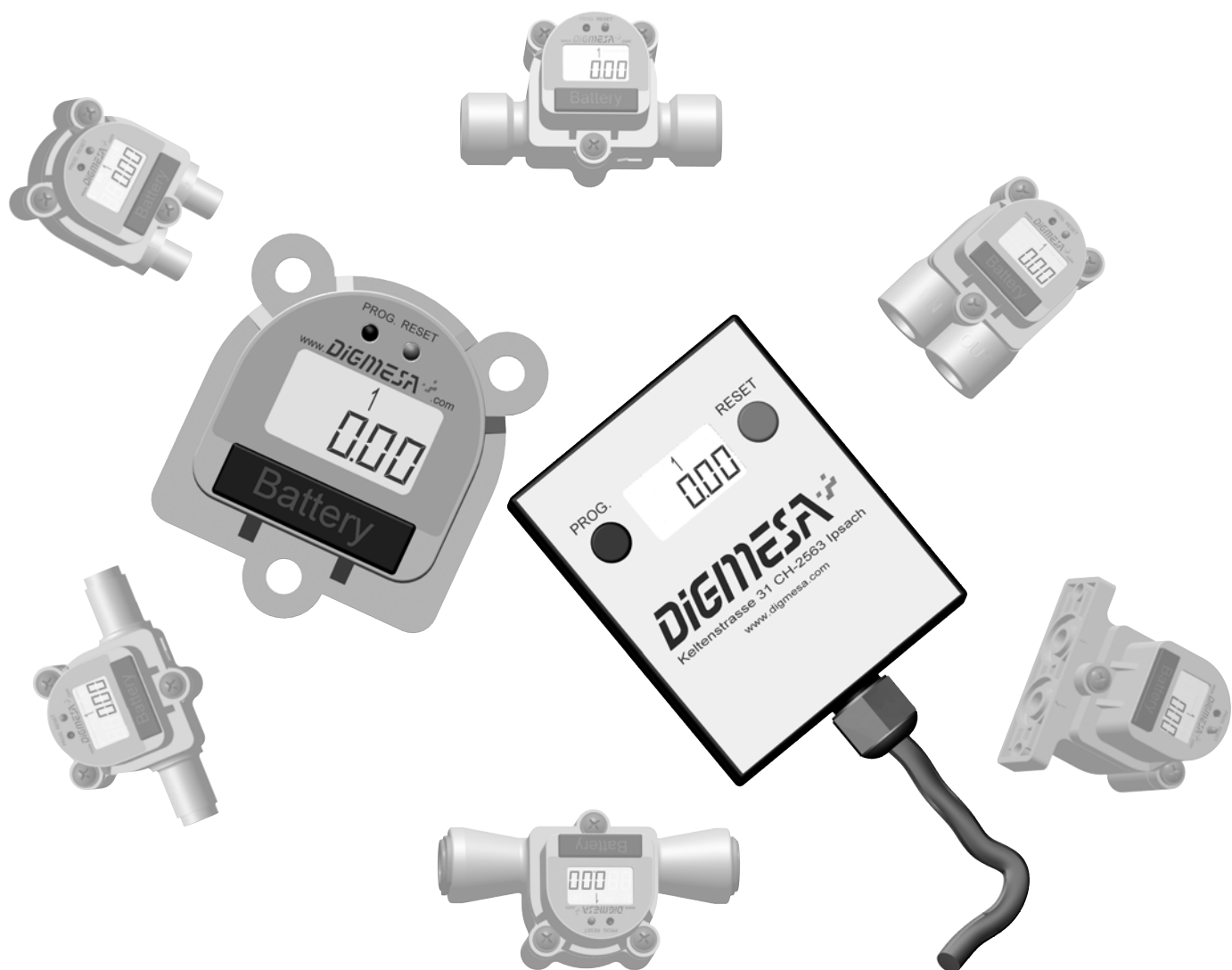

DigmaSA

DigmaSA AG, Keltenstrasse 31, CH-2563 Ipsach / Switzerland

Phone +41 (32) 332 77 77, Fax +41 (32) 332 77 88

www.digmaSA.com

Contents

1	Safety information	3
2	Introduction	4
3	Display symbols and their significance	4
4	Placing the FHK(U)-LCD / Extern into operation	5
5	FHK-LCD programming functions	6
6	Setting PRG/Changing the 4-digit security code	7
7	PRG1 Setting the time/date	8
8	PRG2 Setting the limit value	9
9	PRG3 Setting the time limit value	10
10	PRG4 Setting the calibration value (manual)	11
11	PRG5 Setting the calibration value (automatic)	12
12	Unlocking the flow sensor	13
13	FHK-LCD query and display function	14
14	Resetting the flow sensor	15
15	Operating structure, programming functions	16
16	Operating structure, query and display function	17
17	Operating structure, unlocking the security function	18

1 Safety information

1. Please read through these Operating Instructions carefully before placing the unit into operation. Perform all steps precisely as instructed.
2. Note all instructions and illustrations.
3. Please use only commercially available batteries of type CR2032.
4. Ensure that the battery cover is fitted correctly. Otherwise, foreign bodies and moisture could penetrate the Flow Sensor.
5. Disconnect the electrical power supply immediately (remove the battery) and consult a technician in the following cases:
 - If water or other fluids have penetrated the unit
 - If the unit is not functioning correctly despite precisely following all the instructions given below
 - If the unit is dropped and the housing is damaged
 - If the unit's display does not function correctly
 - If the PROG. or RESET button is not functioning

Never attempt to carry out repairs yourself or to fix a problem by randomly pressing the PROG. or RESET button.



The incorporated electronic circuit will not function without a power supply. Measurement is not possible if the unit is operated without a battery or if the battery is flat.

1.1 Installation

The unit may be installed only by qualified specialists following the safety regulations conventional at the installation location.

Please follow the instructions below for installation:

- The flow direction must correspond to the marked flow direction on the unit
- The measuring instrument must be installed horizontally
- The unit may not be subjected to mechanical loading
- Only seals and connectors suitable for the scheduled operating conditions may be used
- The pipes upstream and downstream of the unit must be supported
- The system must be bled before placing into operation

2 Introduction

The FHK-LCD flow sensor was developed for measuring and monitoring the consumption of fluids. The incorporated liquid-crystal display (LCD) informs the user of the flow quantity, the current flow rate and the whereabouts of a predefined quantity. A security code prevents tampering by unauthorised persons.

Example applications:

- Monitoring filter cartridges
- Monitoring ion exchangers
- Monitoring counter and bar serving quantities
- Monitoring cooling circuits
- etc...

3 Display symbols and their significance

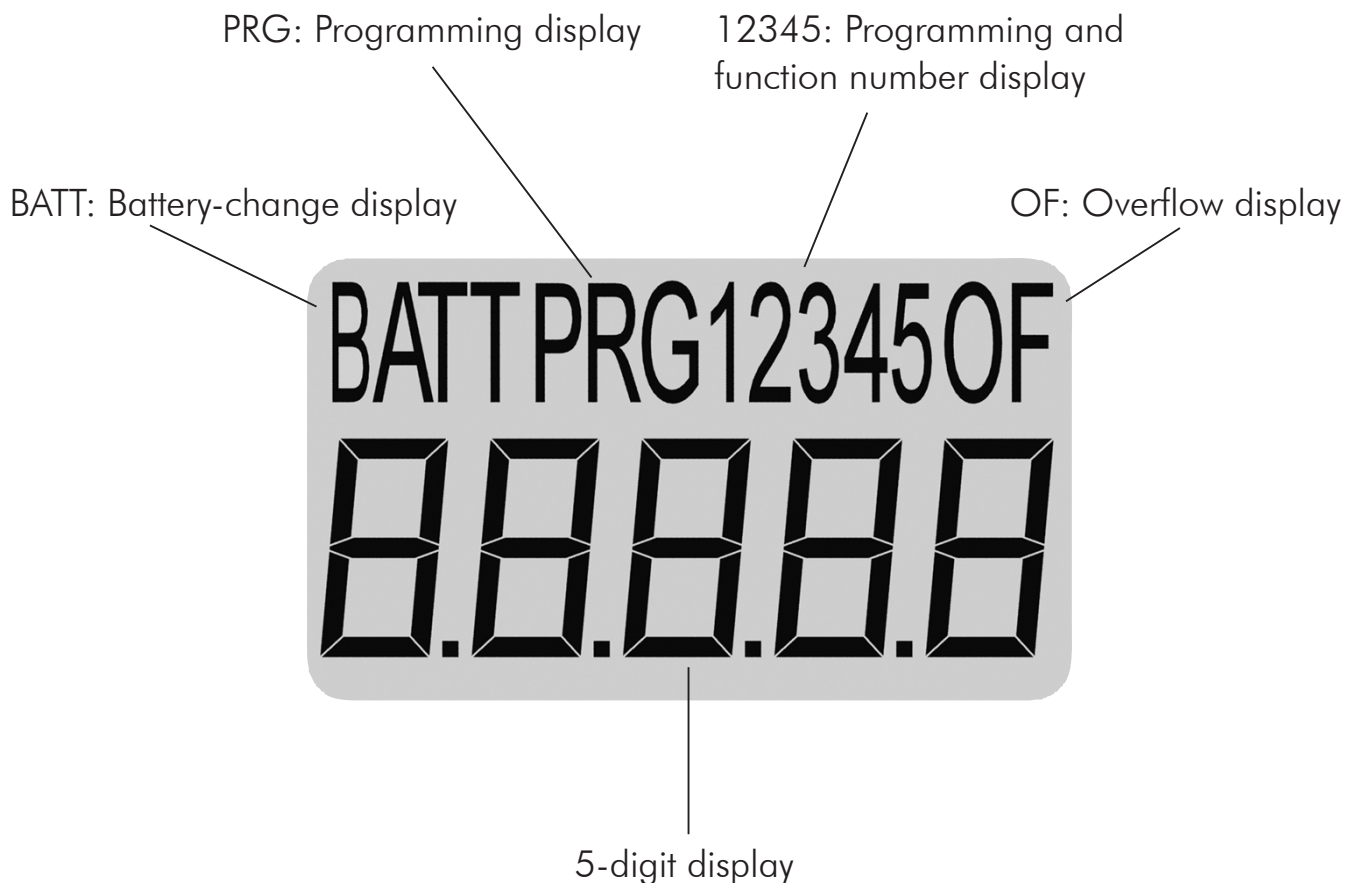

4 Placing the FHK(U)-LCD / Extern into operation



1. Remove the battery / housing cover.

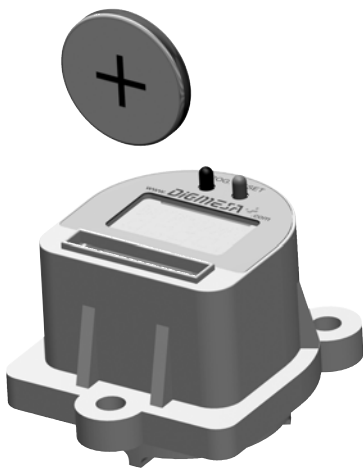
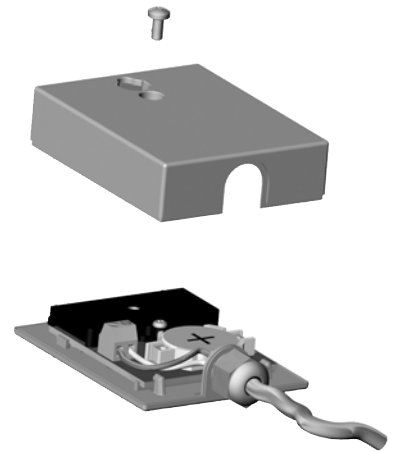

2. Fit the supplied CR2032 battery as illustrated and push it firmly down.

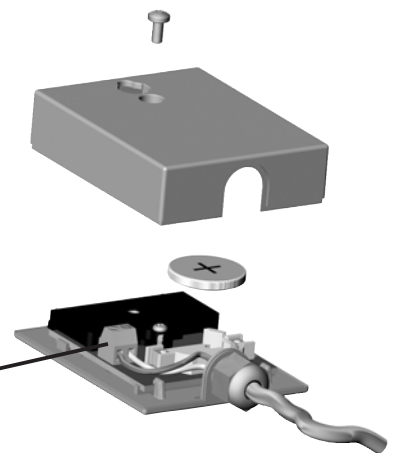

If necessary, the cable between display unit and sensor can be separated from the strip.

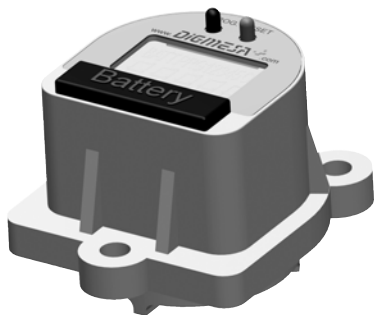

3. Reattach the cover on the battery / housing cover compartment. Ensure that it contacts the battery compartment flat. A splashproof enclosure (IP X4) can be guaranteed only if the battery / housing cover is correctly fitted.

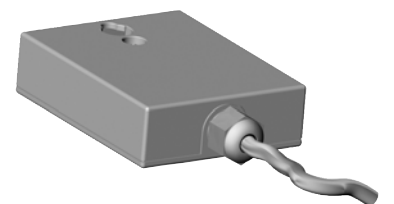

4. The measuring instrument is now in **Upcounter** mode and is ready for operation.



5 FHK-LCD programming functions

PRG Setting the security code

4-digit security code.

The security function is deactivated if the value of the security code is 0000.



PRG1 Setting time/date

24 h time format (hh-mm)/date (DD.MM.YY).

The current date is saved under Hd (history date) each time the unit is reset.



PRG2 Setting the limit value

Limit value in litres (0 to 99999)

The limit value corresponds to the number of litres before an alarm is triggered and is the initial value when downcounting.

The limit function and downcounter are deactivated if the limit value is 0.



PRG3 Setting the time limit value

Time limit value in months (0 to 99)



The time limit value corresponds to the number of months before an alarm is triggered.

The time limit function is deactivated if the time limit value is 0.

PRG4 Setting the calibration value (manual)

Calibration value in pulses per litre (1 to 65000)

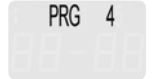

PRG5 Setting the calibration value (automatic)

This function automatically calculates and sets the calibration value of the entire installation and the medium to be measured.

The weight of the flow medium is entered in gram.

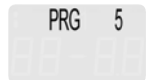

Important: All descriptions in these Instructions start in **Upcounter** mode (see illustration).



6 PRG Setting/Changing the 4-digit security code

IMPORTANT: If the security function is active, the unit must first be unlocked as described in Chapter 12 (Page 13).

Make a note of the security code. The unit cannot be reset and the settings cannot be changed without entering the security code.

The security function is deactivated with the factory-set value 0000.

Initial situation: The unit is in **Upcounter** mode (see illustration).



Choose the PRG function with the PROG. button. Example: Press the PROG. button for two seconds "PRG".



Activate the function by pressing the RESET button. The digit at the right blinks.



Set the required value by pressing the RESET button. Example: The number "2": press twice.



Press the PROG. button once to switch to the next digit (the second digit blinks).



Set the required value by pressing the RESET button. Example: The number "6": press six times.

Repeat these steps until all digits have been set. Example: "1162".



Press the PROG. button until "PRG" blinks. If the setting is to be corrected in "PRG", you can repeat the procedure by pressing the RESET button again.



If all settings have been made, press the PROG. button repeatedly until the unit switches to **Upcounter** mode (see illustration).

If no button is pressed for one minute, the security function is activated. The unit can then be unlocked again only by entering the security code.



7 PRG1 Setting time/date

IMPORTANT: If the security function is active, the unit must first be unlocked as described in Chapter 12 (Page 13).

Initial situation: The unit is in **Upcounter** mode (see illustration).



Choose the PRG1 function with the PROG. button. Example: Press the PROG. button for 2 seconds, until PRG is displayed. Then press the PROG. button again "PRG1".



Activate the function by pressing the RESET button. The digit at the right blinks.



Set the required value by pressing the RESET button. Example: The number "3": press three times.

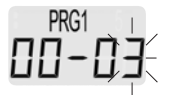

Press the PROG. button once to switch to the next digit (the second digit blinks).



Set the required value by pressing the RESET button. Example: The number "2": press twice.



Repeat these steps until all digits have been set. Example: "14-23".



Press the PROG. button once to access the function for setting the date. The digit at the right blinks.



Repeat these steps until all digits have been set. Example: "01.10.04".



Press the PROG. button until "PRG1" blinks. If the setting is to be corrected in "PRG1", you can repeat the procedure by pressing the RESET button again.

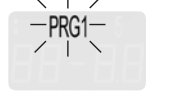

If all settings have been made, press the PROG. button repeatedly until the unit switches to **Upcounter** mode (see illustration).





8 PRG2 Setting the limit value

IMPORTANT: If the security function is active, the unit must first be unlocked as described in Chapter 12 (Page 13).

Initial situation: The unit is in **Upcounter** mode (see illustration).

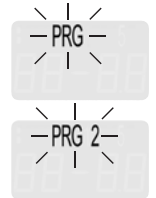
 Choose the PRG2 function with the PROG. button. Example: Press the PROG. button for 2 seconds, until PRG is displayed. Then press the PROG. button a further two times "PRG2".



 Activate the function by pressing the RESET button. The digit at the right blinks.

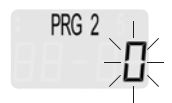

 Set the required value by pressing the RESET button. Example: The number "1": press once.



 Press the PROG. button once to switch to the next digit (the second digit blinks).

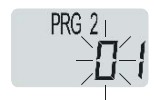

 Set the required value by pressing the RESET button. Example: The number "5": press five times.

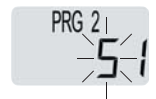

Repeat these steps until all digits have been set. Example: "00051".



 Press the PROG. button until "PRG2" blinks. If the setting is to be corrected in "PRG2", you can repeat the procedure by pressing the RESET button again.



 If all settings have been made, press the PROG. button repeatedly until the unit switches to **Upcounter** mode. No places after the decimal point are displayed if a limit value has been set (see illustration).



9 PRG3 Setting the time limit value

IMPORTANT: If the security function is active, the unit must first be unlocked as described in Chapter 12 (Page 13).

Initial situation: The unit is in **Upcounter** mode (see illustration).

 Choose the PRG3 function with the PROG. button. Example: Press the PROG. button for 2 seconds, until PRG is displayed. Then press the PROG. button a further three times "PRG3".



 Activate the function by pressing the RESET button. The digit at the right blinks.

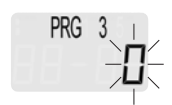

 Set the required value by pressing the RESET button. Example: The number "2": press twice.



 Press the PROG. button once to switch to the next digit (the second digit blinks).



 Set the required value by pressing the RESET button. Example: The number "1": press once.



 Press the PROG. button until "PRG3" blinks. If the setting is to be corrected in "PRG3", you can repeat the procedure by pressing the RESET button again.



 If all settings have been made, press the PROG. button repeatedly until the unit switches to **Upcounter** mode (see illustration).



 **IMPORTANT:** The alarm date is updated only after a reset. You must reset the unit as described in Chapter 14 in order to calculate the alarm date with the new time limit value.

10 PRG4 Setting the calibration value (manual)

IMPORTANT: If the security function is active, the unit must first be unlocked as described in Chapter 12 (Page 13).

Initial situation: The unit is in **Upcounter** mode (see illustration).

 Choose the PRG4 function with the PROG. button. Example: Press the PROG. button for 2 seconds, until PRG is displayed. Then press the PROG. button a further four times "PRG4".



 Activate the function by pressing the RESET button. The digit at the right blinks (factory default setting: 100 pulses/litre).

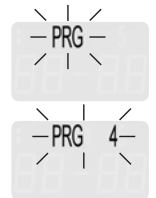

 Set the required value by pressing the RESET button. Example: The number "6": press six times.



 Press the PROG. button once to switch to the next digit (the second digit blinks).



 Set the required value by pressing the RESET button. Example: The number "3": press three times.

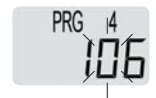

 Press the PROG. button once to switch to the next digit (the third digit blinks).



Repeat these steps until all digits have been set. Example: "00236".



 Press the PROG. button until "PRG4" blinks. If the setting is to be corrected in "PRG4", you can repeat the procedure by pressing the RESET button again.



 If all settings have been made, press the PROG. button repeatedly until the unit switches to **Upcounter** mode (see illustration).

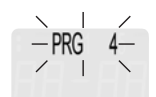

11 PRG5 Setting the calibration value (automatic)

IMPORTANT: If the security function is active, the unit must first be unlocked as described in Chapter 12 (Page 13).

Initial situation: The unit is in **Upcounter** mode (see illustration).

 Choose the PRG5 function with the PROG. button. Example: Press the PROG. button for 2 seconds, until PRG is displayed. Then press the PROG. button a further five times "PRG5".

 Activate the function by pressing the RESET button. A "-" is displayed.

Now dispense approx. 1 litre of the medium. This dispensing operation is shown on the display ("--", "-- --", "----", "-----").

 Pressing the RESET button displays a blinking digit at the right. This is where the weight (in g) of the flow medium is entered.

 Set the required value by pressing the RESET button. Example: The number "2": press twice.

 Press the PROG. button once to switch to the next digit (the second digit blinks).

 Set the required value by pressing the RESET button. Example: The number "6": press six times.

Repeat these steps until all digits have been set. Example: "01162" (for 1162 g).

 Press the PROG. button until "PRG5" blinks. If the setting is to be corrected in "PRG5", you can repeat the procedure by pressing the RESET button again.

 If all settings have been made, press the PROG. button repeatedly until the unit switches to **Upcounter** mode (see illustration).

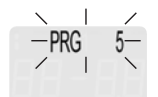
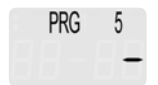
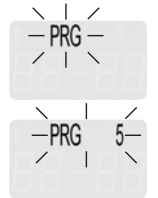



12 Unlocking the flow sensor

Initial situation: The unit is in **Upcounter** mode (see illustration).

 Press the PROG. button for 2 seconds. If the security function is active, a „ticker“ text „COdE“ is displayed, followed by „---0“.

If the security function is not active, „PRG“ blinks on the display.

 Set the required value by pressing the RESET button. Example: The number “2”: press twice.

 Press the PROG. button once to switch to the next digit (the second digit blinks).

 Set the required value by pressing the RESET button. Example: The number “6”: press six times.

Repeat these steps until all digits have been set. Example: “1162”.

 Press the PROG. button once. If the set value is correct, the set code blinks on the display. The unit then switches back to **Upcounter** mode (see illustration).

The unit is now unlocked. All functions and settings can be performed or changed.

If the set value is incorrect, „FAIL“ is shown on the display. The unit then switches back to **Upcounter** mode (see illustration).

All security-protected functions and settings remain locked.

The security function is reactivated if no button is pressed for one minute.

13 FHK-LCD query and display function

You can switch between the various query and display functions by pressing the Reset button.

Upcounter (1 on the display)



Displays the flow quantity in litres.

Measuring range without limit function: 0 to 99999 litres with max. 3 places after the decimal point (dependent on the number of pulses).

With limit function: 0 to 99999 litres (no place after the decimal point).

„OF“ (OverFlow) is displayed if 99999 is exceeded.



Alarm functions: Display blinks when the limit value or the alarm date is reached.

Downcounter (2 on the display)



Displays the remaining quantity in litres through to alarm.

Measuring range without limit function: Downcounter is deactivated. „OFF“ is shown on the display.

With limit function: 99999 to -9999 litres (no place after the decimal point).

„OF“ (OverFlow) is displayed if -9999 is undershot.



Alarm functions: Display blinks when value 0 litres or alarm date is reached.

Instantaneous value (3 on the display)



Displays the current flow rate in l/min.

Measuring range: 0 to 999.99 l/min with 2 places after the decimal point.

Time / date (4 on the display)



Displays the time and the date.

Alarm-date (5 on the display)



Without time limit function: The alarm date is deactivated. „OFF“ is shown on the display.

With time limit function: The alarm date is displayed.

History 1-5

The 5 last history values are displayed. They are displayed consecutively with the memory level (1-5). The data of the last reset is saved at memory level 1.

The following values are displayed as a „ticker“ text:

- HL (History Liter) flow quantity
- Hd (History date) reset-date

14 Resetting the flow sensor

IMPORTANT: If the security function is active, the unit must first be unlocked as described in Chapter 12 (Page 13).

Initial situation: The unit is in **Upcounter** mode (see illustration).



Press the RESET button for approx. 4-5 seconds. "rESEt" is displayed.



Briefly press the RESET button again within 3 seconds. Display "rESEt" blinks to confirm reset.



Upcounter is reset to "0.00" and downcounter is reset to the set limit value.



The value of the reset **Upcounter** function and the current date are saved (history memory level 1).

If the time limit function is activated, the alarm date is recalculated. The number of months of the time limit value is added to the current date.

Important: Both counters (**Upcounter** and **Downcounter**) are always reset if a Reset is performed.

15 Operating structure, programming functions

 — Choose digit

 — Set blinking digit

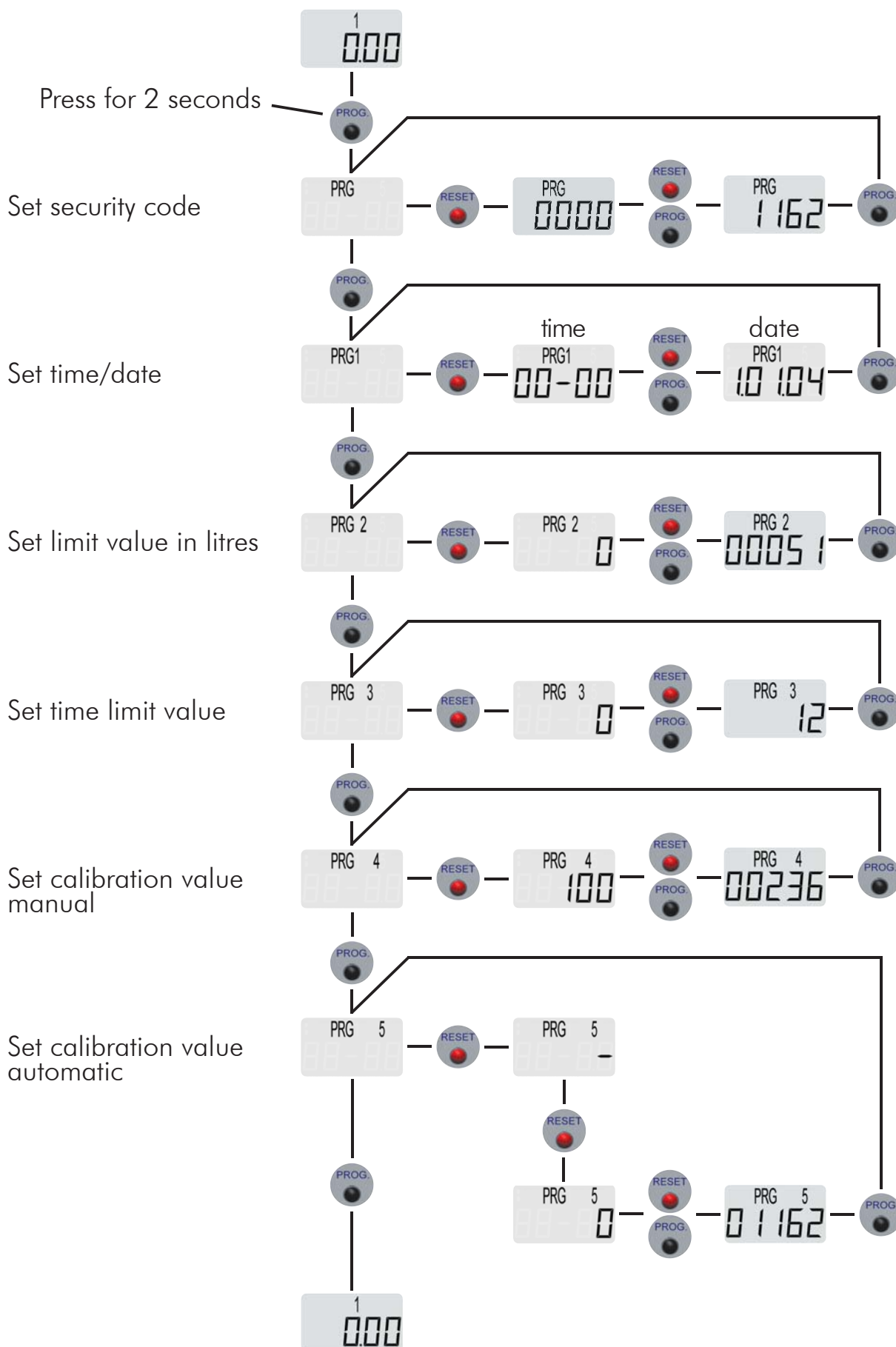

16 Operating structure, query and display function

—  — Choose digit

—  — Set blinking digit

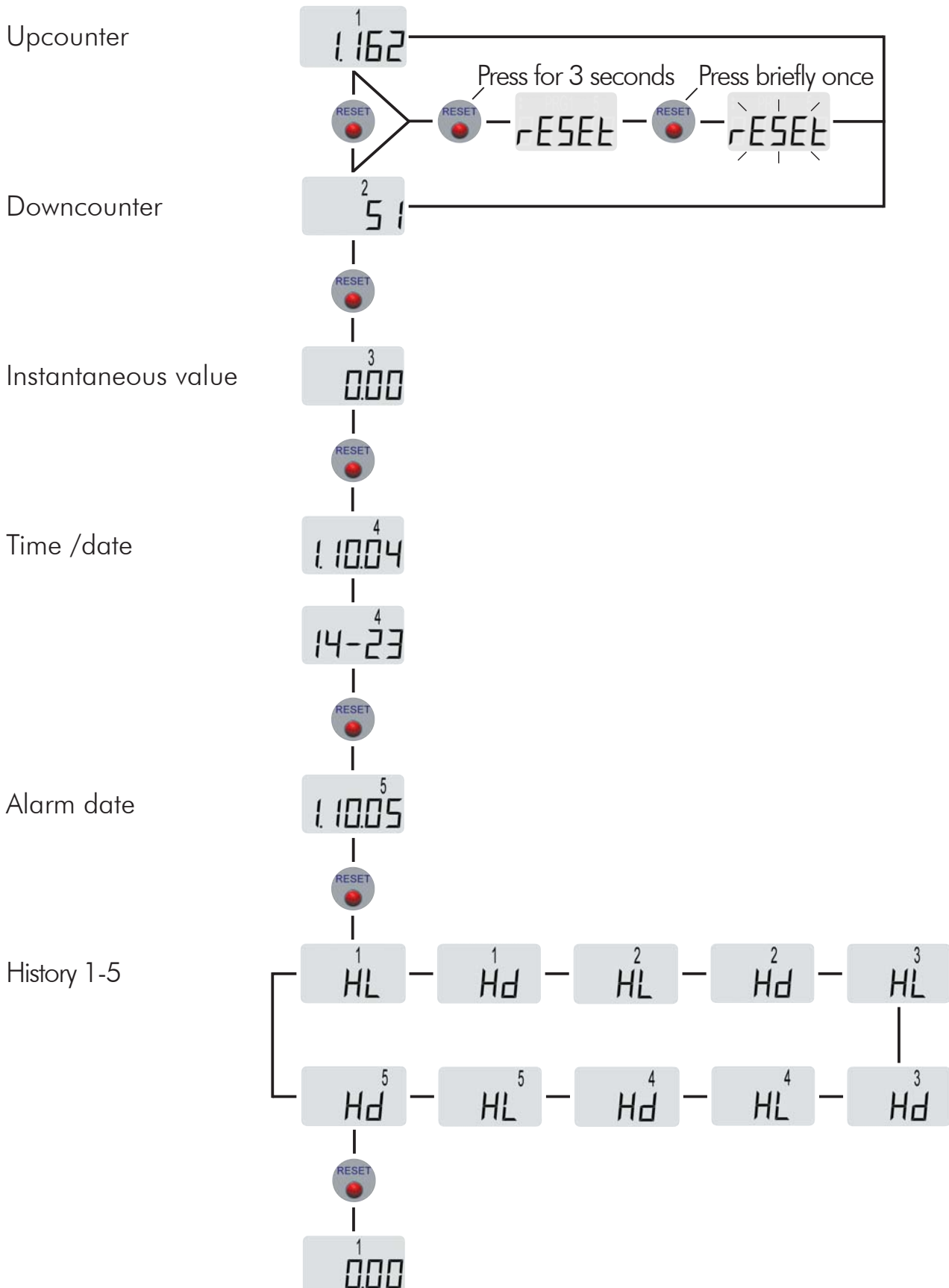

17 Operating structure, unlocking the security function

—  — Choose digit

—  — Set blinking digit

Upcounter

